



CATALOGO
Catalogue



CATALOGO

Catalogue



v. 25.01



Ambition

*Not only form and function.
Until the product will not have reached
the right combination, we will work with
the objective of obtaining perfection
in the development and production
process.*

Ambition

*Pas seulement forme et fonction.
Jusqu'à ce que le produit ait atteint la
bonne combinaison, nous travaillerons
dans le but d'atteindre la perfection
dans le processus de développement et
de production.*





AMBIZIONE

NON SOLO FORMA E FUNZIONE.
FINO A QUANDO IL PRODOTTO NON AVRÀ
RAGGIUNTO LA GIUSTA COMBINAZIONE,
LAVOREREMO CON L'OBIETTIVO
DI OTTENERE LA PERFEZIONE NEL
PROCESSO DI SVILUPPO E PRODUZIONE.



INDICE *Index*

**VALVOLE A SFERA
E RUBINETTI**
Ball Valves and Bibcocks
*Vannes et robinets
à boisseau
sphérique*

SERIE HEAVY
Series Série



p **8**

**VALVOLE CON
MANIGLIA A T**
*Valve with
T handle
Vanne avec
poignée à T*



da p **9** a **17**

SERIE STRONG
Series Série



p **10**

SERIE STRONG DZR
Series Série



p **19**

**VALVOLE
AVANT-CONTATORE**
*Ball valve water meter
Vanne à sphère pour
compteur
d'eau*



p **20**

SCARICO CALDAIA
*Boiler drain-off
Robinet purgeur
pour chaudière*



p **21**

RUBINETTO ENOLOGICO
*Wine tap
Robinet œnologique*



p **21**

**VALVOLE GAS
DA INCASSO**
*Built-in gas ball valve
Vanne à
boisseau
sphérique
pour GAS
à encastrer*



p **30**

SERIE GAS
Series Série



p **34**

SERIE GASTRONG
Series Série



p **35**

COMPONENTI IDRICI
*Hydronic components
Composants
hydrauliques*

**RIDUTTORI
DI PRESSIONE**
*Pressure
reducers
Réducteurs
de pression*



p **42**

**GRUPPI DI
ALIMENTAZIONE**
*Filling valves
Groupes
alimentation*



p **42**

**RUBINETTI SOTTOLAVABO
E ATTACCO LAVATRICE**
*Under-wash basin tap and
washing machine tap
Robinets d'arrêt pour
lavabo et robinets
pour machine à laver*

**RUBINETTI
SOTTOLAVABO
D'ARREDO**
*Design under-wash basin tap
Robinets d'arrêt
décoratif
pour lavabo*



p **44**

**VALVOLE ED ACCESSORI
PER CORPI SCALDANTI**
*Heating valves and
accessories
Vannes et accessoires
pour corps chauffant*

TESTE TERMOSTATICHE
*Thermostatic head
Tête
thermostatique*



p **52**

VALVOLE H
*H-valves
Vannes H*



p **54**

VALVOLE D'ARREDO
*Design valves
Vannes décoratif*

SCALDASALVIETTE
*Towel
Sècheserviettes*



p **88**

**VALVOLE H
TERMOSTATIZZABILI**
*Thermostatic
H-valves
Vannes H
thermostatizable*



p **90**

**VALVOLE
TERMOSTATIZZABILI
MONOTUBO**
*Thermostatic valves
monotube
Vannes thermostatizable
monotube*



p **96**

**COLLETTORI DI
DISTRIBUZIONE
E RACCORDI**
*Manifolds
Collecteurs de
distribution*



SERIE **BIG**
Series Série



p **12**

VALVOLA CON BOCCHETTONE
Ball valve with tail
Vanne sphérique avec raccord



p **13**

VALVOLA CON SPURGO
Drain-off valve
Vanne sphérique avec purgeur



p **14**

SERIE **BEST**
Series Série



p **16**

SERIE **MINI**
Series Série



p **22**

RUBINETTI DA GIARDINO
Garden bibcock
Robinets de puisage



p **24**

VALVOLE DA INCASSO
Built-in ball valve
Vannes à encastrer



p **27**

VALVOLE A SFERA PER GAS
Gas ball valves
Vannes à boisseau sphérique pour Gas

FILTRI
Filter
Filtres



p **39**

VALVOLE DI RITEGNO
Check-valve
Soupapes



p **40**

VALVOLE A CLAPET
Swing pattern valve
Clapet à battants



p **41**

SARACINESCHE
Gate valve
Vannes à passage direct



p **41**

PRESE ACQUA D'ARREDO
Design water connections
Sortie d'eau décoratif



p **45**

RUBINETTI SOTTOLAVABO A SFERA
Under-wash basin ball tap
Robinets d'arrêt à sphère pour lavabo



p **46**

RUBINETTI SOTTOLAVABO A VITONE
Under-wash headwork tap
Robinets d'arrêt avec tête pour lavabo



p **48**

RUBINETTI ATTACCO LAVATRICE
Washing machine tap
Robinets pour machine à laver



p **50**

VALVOLE D'ARREDO TONDE
Round design valves
Vannes décoratif rond



p **59**

VALVOLE D'ARREDO QUADRE
Square design valves
Vannes décoratif carrée



p **75**

ADATTATORI
Adapters
Raccords



p **84**

KIT COPRI TUBO
Cover set
Kit de couvre tuyaux



p **86**

COLLETTORI LINEARI
Linear manifolds
Collecteurs linéaires



p **109**

VALVOLE DI SICUREZZA
Safety valves
Vannes de sûreté

VALVOLE DI SFOGO ARIA
Air vents
Purgeurs d'air



p **111**

VALVOLE DI SICUREZZA
Safety valves
Vannes de sûreté



p **113**

CERTIFICAZIONI *Certifications*



ISO 9001:2015

Bureau Veritas Certification

A P M S.R.L.
Via Mirabella, 1 - 28013 GATTICO VERENO (NO) - Italy
Certified site:
Via Mirabella, 1 - 28013 GATTICO VERENO (NO) - Italy

Bureau Veritas Italia S.p.A. certifies that the Management System of the above organization has been audited and found to be in accordance with the requirements of the management system standard identified below:

ISO 9001:2015

Scope of certification

Design, commercialization and manufacture of ball valves, hydraulic and hydro thermal components.
SAT: 18, 29

Original Cycle Start Date: 30 November 2010
Expiry date of previous cycle: 28 October 2024
Certification / Recertification Audit Date: 12 July 2024
Certification/Recertification Cycle Start Date: 09 October 2024
Subject to the continued satisfactory operation of the organization's Management System, this certificate expires on: 28 October 2027

Certificate No. IT336355 Version: 1 Revision date: 09 October 2024

[Signature]
General Manager

Certification Body Address:
Bureau Veritas Italia S.p.A., Viale Alpini, 34F - 20124 Milano, Italy

For more information regarding the scope of this certificate and the responsibilities of the management system, please refer to the standard to which the organization is certified.

To check the validity of this certificate please visit www.bv.com



PED 2014/68/UE

ACCREDIA Bureau Veritas Italia SpA S.p.A. Certified Body under the number 1370

EUROPEAN CONFORMITY

CERTIFICATE OF QUALITY SYSTEM APPROVAL
N° CE-1370-PED-D1-APM 001-2447A

Bureau Veritas Italia SpA, acting within the scope of its verification contract (contract number: 1370), attests that the quality system operated by the manufacturer for production, final product inspection and testing of the pressure equipment identified hereafter has been examined against the provisions of article 8, paragraph 2), of the Pressure Equipment Directive (2010/65/EU) in order to verify the production of the structure identified below:

Manufacturer:	APM S.R.L.
Address:	VIA MIRABELLA, 1 GATTICO VERENO (NO) - ITALY
Trading Name - Mark:	APM S.R.L.
Equipment/Pressure Declaration:	Pressure 2 Pressure 3 Valve 2 Valve
Identification of equipment (as contained in or on the label):	Pressure 2 Pressure 3 Valve 2 Valve
Identification of equipment (as contained in or on the label):	Pressure 2 Pressure 3 Valve 2 Valve
This certificate will expire on:	09/10/2027

The approval is conditional upon the surveillance audits, visits, tests and verifications to be carried out by the local Bureau Veritas entity that entered into a contract with the manufacturer, pursuant to the provisions of each contract.

This certificate shall be renewed in accordance with the provisions of article 8, paragraph 2), of the Pressure Equipment Directive (2010/65/EU) in order to verify the production of the structure identified below:

State:	IT	Region and Province:	LOMBARDY	City:	MIANO
Province:	MI	Region and Province:	LOMBARDY	City:	MIANO

Page 1 of 2



EN 331:2015

CELAD®
Via Melegnano, 10
24100 Carpi (MO)
Italy
www.celad.com

celab®

CERTIFICATE
- USE OF STANDARD -

Certificate Number UCN : 80283739000
Date of Issue : 2025-10-21
Certificate valid up to : 2026-10-20

Brand Name : CELAD
Type : Gas valve
Models : 3040 1/2", 3040 3/4", 3040 1", 3040 1 1/4", 3040 1 1/2", 3040 2", 3040 2 1/2", 3070 1", 3070 1 1/4", 3070 1 1/2", 3070 2"

Manufacturer : APM S.R.L.
Address : VIA MIRABELLA 1-28013 GATTICO VERENO ITALY
Standard Used : EN 331:2015

Conclusion:
After inspection of the technical documentation provided by the customer, and in his request, we express our opinion as indicated and stated in the following checklist.

This opinion is only valid for the equipment and configuration described in conjunction with the test data detailed above and with compliance with all applicable legal requirements for the product.

The following manufacturing agreements are mentioned:
[Presence of test report using standards as indicated by the manufacturer:] CE.

Copyright of this Certificate is owned by CELAD®. Copy and reuse are not permitted without the prior approval of the General Manager. Use of this certificate is subjected to Celad regulation available on Celad website.

Check the authenticity of this certificate and related information before use in the web site www.celab.com. Introducing the UCN number in the "Check document authenticity" area. You will see copy of this certificate and regulation on certificate use. This document is released only for scope allowed by law.

Manufacturing Director
General Manager - CELAD
www.celad.com

www.celab.com

Doc 125 Voluntary Certificate of Standard rev 1.3



VALVOLE A SFERA E RUBINETTI

Ball Valves and Bibcocks

Vannes et robinets à boisseau sphérique



PASSAGGIO
Way
Étape



SPESSORE FILETTO
Thickness thread
Épaisseur du filetage



LUNGHEZZA FILETTO
Lenght thread
Longueur du filetage



PESO
Weight
Poids

SERIE HEAVY

Series Série



SERIE STRONG

Series Série



SERIE BIG

Series Série



SERIE BEST

Series Série



SERIE STRONG DZR *Series Série*

VALVOLE AVANT-CONTATORE

Ball valve for water meter *Vanne à sphère pour compteur d'eau*

SCARICO CALDAIA

Boiler drain-off *Robinet purgeur pour chaudière*

SERIE MINI *Series Série*

RUBINETTI DA GIARDINO

Garden bibcock *Robinets de puisage*

RUBINETTO ENOLOGICO

Wine tap *Robinet oenologique*

VALVOLE DA INCASSO

Built-in ball valve *Vannes à encastrer*

SERIE HEAVY Series Série

VALVOLA A SFERA, SERIE HEAVY, A PASSAGGIO TOTALE IN OTTONE STAMPATO, SABBIA TO E NICHELATO.

- ASTA IN OTTONE CON TRIPLA TENUTA: DOPPIO ORING E ANELLO IN PTFE; MONTATA DALL'INTERNO CONTRO LE MANOMISSIONI E/O L'ESTRAZIONE E ANTISCOPPIO
- PREMISTOPPA IN OTTONE
- SFERA DIAMANTATA E CROMATA
- SEDI IN PTFE
- LEVA IN: ALLUMINIO [SERIE T] O IN ACCIAIO ZINCATO CON RIVESTIMENTO IN PVC [SERIE ST]
- FILETTATURE SECONDO ISO 7/1
- LIMITI DI PRESSIONE 40 BAR (PN 40)
- LIMITI DI TEMPERATURA -20 +130 °C

Full way ball valve, HEAVY series, made of forged brass, sand-blasted and nickel plated.

- Brass stem with triple tightness: double Oring and PTFE ring; assembled from inside to avoid tampering, extraction or explosion
- Stuffing box made of brass
- Solid ball with cleaned and chromium plated surface
- PTFE seats
- Lever made of aluminium [T series] or made of steel with PVC coating [ST series]
- Threads according to ISO 7/1
- Pressure limits 40 bar (PN 40)
- Temperature range -20 +130 °C

Vanne à boisseau sphérique, série HEAVY, en laiton matricé, sablé et nickelé, passage intégral.

- Tige en laiton avec triple étanchéité: double o-ring et bague en PTFE montée de l'intérieur contre les altérations et/ou l'extraction et anti éclat
- Presse étoupe en laiton
- Sphère diamantée et chromée
- Sièges en PTFE
- Poignée: en aluminium [série T] ou en acier avec revêtement en PVC [série ST]
- Filetages selon ISO 7/1
- Limites de pression 40 bar (PN 40)
- Limites de température -20 +130 °C



PASSAGGIO TOTALE
Full way
Passage intégral
PN40

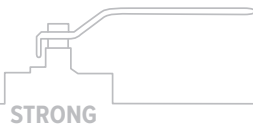

PASSAGGIO TOTALE
Full way
Passage intégral
PN40

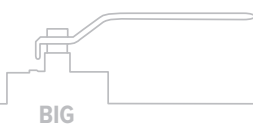

PASSAGGIO TOTALE
Full way
Passage intégral
PN30

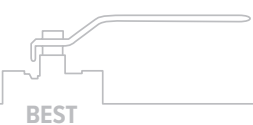

PASSAGGIO STANDARD
Standard way
Passage standard
PN25

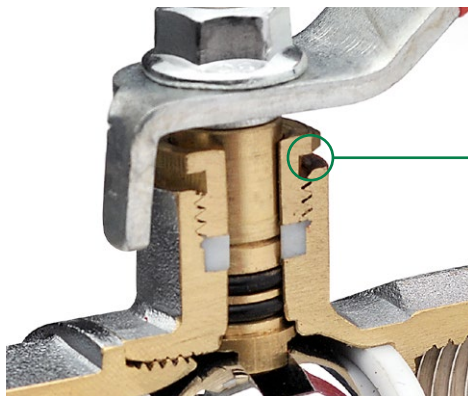

Asta in ottone con tripla tenuta: doppio Oring e anello in PTFE.

Brass stem with triple tightness: double Oring and PTFE ring

Tige en laiton avec triple étanchéité: double o-ring et bague en PTFE.

PREMISTOPPA Stuffing box Presse étoupe

1170 STN

VALVOLA A SFERA SERIE HEAVY IN OTTONE NICHELATO, A PASSAGGIO TOTALE, FILETTATURA F/F, CON PREMISTOPPA.

LEVA PIATTA NERA IN ACCIAIO.

Full way ball valve F/F, HEAVY series, made of brass, nickel plated, with stuffing box. Black flat steel lever.

Vanne à boisseau sphérique, série HEAVY, en laiton nickelé, passage intégral F/F à presse étoupe, poignée acier noire.



FORO HOLE
ANTILEGIONELLA

ACS *CE 1370
PED2014/68/AE

Codice Code	Misura Size Dimensions	☐	📦
1170STN 015	1/2"	25	100
1170STN 020	3/4"	15	60
1170STN 025	1"	12	48
1170STN 032*	1"1/4	5	20
1170STN 040*	1"1/2	4	16
1170STN 050*	2"	1	12

1220 STN

VALVOLA A SFERA SERIE HEAVY IN OTTONE NICHELATO, A PASSAGGIO TOTALE, FILETTATURA M/F, CON PREMISTOPPA.

LEVA PIATTA NERA IN ACCIAIO.

Full way ball valve M/F, HEAVY series, made of brass, nickel plated, with stuffing box. Black flat steel lever.

Vanne à boisseau sphérique, série HEAVY, en laiton nickelé, passage intégral M/F à presse étoupe, poignée acier noire.



FORO HOLE
ANTILEGIONELLA

ACS *CE 1370
PED2014/68/AE

Codice Code	Misura Size Dimensions	☐	📦
1220STN 015	1/2"	25	100
1220STN 020	3/4"	15	60
1220STN 025	1"	12	48
1220STN 032*	1"1/4	5	20
1220STN 040*	1"1/2	4	16
1220STN 050*	2"	1	10

1170 TN

VALVOLA A SFERA SERIE HEAVY IN OTTONE NICHELATO, A PASSAGGIO TOTALE, FILETTATURA F/F, CON PREMISTOPPA.
FARFALLA ALLUMINIO NERA.

Full way ball valve F/F, HEAVY series, made of brass, nickel plated, with stuffing box. Black aluminium butterfly handle.

Vanne à boisseau sphérique, série HEAVY, en laiton nickelé, passage intégral F/F à presse étoupe, poignée papillon aluminium noire.

**ACS**

Codice Code	Misura Size Dimensions		
1170TN 015	1/2"	30	120
1170TN 020	3/4"	20	80
1170TN 025	1"	12	48

1220 TN

VALVOLA A SFERA SERIE HEAVY IN OTTONE NICHELATO, A PASSAGGIO TOTALE, FILETTATURA M/F, CON PREMISTOPPA.
FARFALLA ALLUMINIO NERA.

Full way ball valve M/F, HEAVY series, made of brass, nickel plated, with stuffing box. Black aluminium butterfly handle.

Vanne à boisseau sphérique, série HEAVY, en laiton nickelé, passage intégral M/F à presse étoupe, poignée papillon aluminium noire.

**ACS**

Codice Code	Misura Size Dimensions		
1220TN 015	1/2"	30	120
1220TN 020	3/4"	20	80
1220TN 025	1"	12	48

1170 M

VALVOLA A SFERA SERIE HEAVY IN OTTONE NICHELATO, A PASSAGGIO TOTALE, FILETTATURA F/F, CON PREMISTOPPA. MANIGLIA A T PROLUNGATA.

Full way ball valve F/F, HEAVY series, made of brass, nickel plated, with stuffing box. With extended T handle.

Vanne à boisseau sphérique, série HEAVY, en laiton nickelé, passage intégral F/F à presse étoupe, poignée à T.



ACS ¹³⁷⁰
PED2014/68/UE

Codice Code	Misura Size Dimensions		
1170M 015	1/2"	25	100
1170M 020	3/4"	15	60
1170M 025	1"	12	48
1170M 032 *	1"1/4	6	24
1170M 040 *	1"1/2	3	12
1170M 050 *	2"	1	12

1220 M

VALVOLA A SFERA SERIE HEAVY IN OTTONE NICHELATO, A PASSAGGIO TOTALE, FILETTATURA M/F, CON PREMISTOPPA. MANIGLIA A T PROLUNGATA.

Full way ball valve M/F, HEAVY series, made of brass, nickel plated, with stuffing box. With extended T handle.

Vanne à boisseau sphérique, série HEAVY, en laiton nickelé, passage intégral M/F à presse étoupe, poignée à T.



ACS ¹³⁷⁰
PED2014/68/UE

Codice Code	Misura Size Dimensions		
1220M 015	1/2"	25	100
1220M 020	3/4"	15	60
1220M 025	1"	12	48
1220M 032 *	1"1/4	6	24
1220M 040 *	1"1/2	3	12
1220M 050 *	2"	1	12

SERIE STRONG Series Série

VALVOLA A SFERA, SERIE STRONG, A PASSAGGIO TOTALE IN OTTONE STAMPATO, SABBIAIO E NICHELATO.

- ASTA IN OTTONE CON PREMISTOPPA, MONTATA DALL'INTERNO CONTRO LE MANOMISSIONI E/O L'ESTRAZIONE E ANTISCOPIO
- SFERA IN OTTONE DIAMANTATA E CROMATA
- SEDI IN PTFE
- DOPPIA TENUTA OR + PTFE
- LEVA IN: ALLUMINIO [SERIE T] O IN ACCIAIO ZINCATO CON RIVESTIMENTO IN PVC [SERIE ST]
- FILETTATURE SECONDO ISO 228
- LIMITI DI PRESSIONE 40 BAR (PN 40)
- LIMITI DI TEMPERATURA -20 +130 °C

Full way ball valve, STRONG series, made of forged brass, sand-blasted and nickel plated.

- Brass stem with stuffing box assembled from inside to avoid tampering, extraction or explosion
- Brass solid ball with cleaned and chromium plated surface
- PTFE seats
- Double seal OR + PTFE
- Lever made of aluminium [T series] or made of steel with PVC coating [ST series]
- Threads according to ISO 228
- Pressure limits 40 bar (PN 40)
- Temperature range -20 +130 °C

Vanne à boisseau sphérique, série STRONG, en laiton matricé, sablé et nickelé, passage intégral.

- Tige en laiton avec presse étoupe montée de l'intérieur contre les altérations et/ou l'extraction et anti éclat
- Sphère diamantée et chromée
- Sièges en PTFE
- Double joint OR + PTFE
- Poignée: en aluminium [série T] ou en acier avec revêtement en PVC [série ST]
- Filetages selon ISO 228
- Limites de pression 40 bar (PN 40)
- Limites de température -20 +130 °C

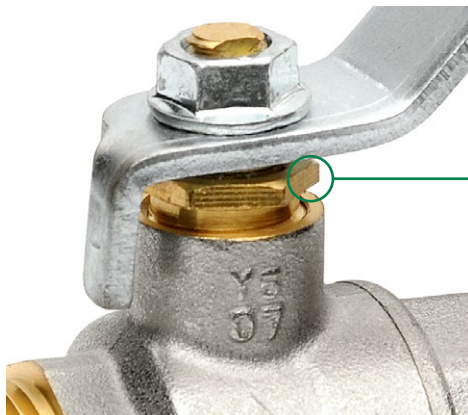
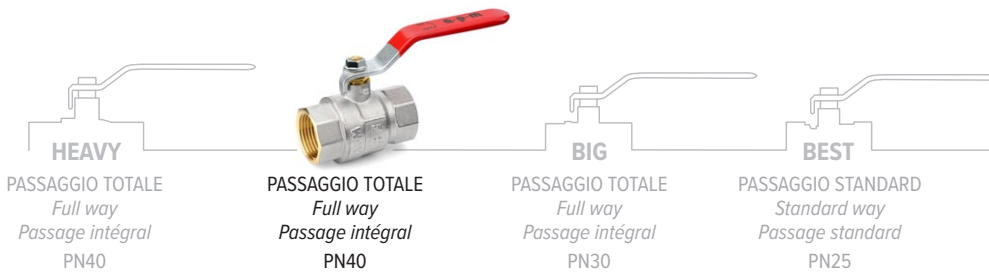

PREMISTOPPA *Stuffing box Presse étoupe*

1150 ST

VALVOLA A SFERA SERIE STRONG IN OTTONE NICHELATO, A PASSAGGIO TOTALE, FILETTATURA F/F, CON PREMISTOPPA. LEVA PIATTA ROSSA IN ACCIAIO.

Full way ball valve F/F, STRONG series, made of brass, nickel plated, with stuffing box. Red flat steel lever.

Vanne à boisseau sphérique, série STRONG, en laiton nickelé, passage intégral F/F à presse étoupe, poignée acier rouge.

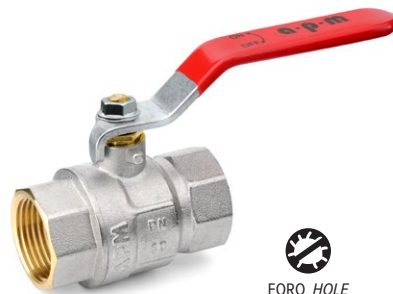

ACS ^{CE} 1370 PED2014/68/UE

Codice Code	Misura Size	Dimensions	PN		
1150ST 015	1/2"		40	25	100
1150ST 020	3/4"		40	20	80
1150ST 025	1"		40	12	48
1150ST 032 *	1 1/4"		30	8	32
1150ST 040 *	1 1/2"		30	4	16
1150ST 050 *	2"		30	1	12

1200 ST

VALVOLA A SFERA SERIE STRONG IN OTTONE NICHELATO, A PASSAGGIO TOTALE, FILETTATURA M/F, CON PREMISTOPPA. LEVA PIATTA ROSSA IN ACCIAIO.

Full way ball valve M/F, STRONG series, made of brass, nickel plated, with stuffing box. Red flat steel lever.

Vanne à boisseau sphérique, série STRONG, en laiton nickelé, passage intégral M/F à presse étoupe, poignée acier rouge.



ACS ^{CE} 1370 PED2014/68/UE

Codice Code	Misura Size	Dimensions	PN		
1200ST 015	1/2"		40	25	100
1200ST 020	3/4"		40	20	80
1200ST 025	1"		40	12	48
1200ST 032 *	1 1/4"		30	8	32
1200ST 040 *	1 1/2"		30	4	16
1200ST 050 *	2"		30	1	12

1150 T

VALVOLA A SFERA SERIE STRONG IN OTTONE NICHELATO, A PASSAGGIO TOTALE, FILETTATURA F/F, CON PREMISTOPPA. FARFALLA ALLUMINIO ROSSA.

Full way ball valve F/F, STRONG series, made of brass, nickel plated, with stuffing box. Red aluminium butterfly handle.

Vanne à boisseau sphérique, série STRONG, en laiton nickelé, passage intégral F/F à presse étoupe, poignée papillon aluminium rouge.



ACS

Codice Code	Misura Size Dimensions	PN	Volume	Weight
1150T 015	1/2"	25	25	100
1150T 020	3/4"	20	20	80
1150T 025	1"	12	12	48

1200 T

VALVOLA A SFERA SERIE STRONG IN OTTONE NICHELATO, A PASSAGGIO TOTALE, FILETTATURA M/F, CON PREMISTOPPA. FARFALLA ALLUMINIO ROSSA.

Full way ball valve M/F, STRONG series, made of brass, nickel plated, with stuffing box. Red aluminium butterfly handle.

Vanne à boisseau sphérique, série STRONG, en laiton nickelé, passage intégral M/F à presse étoupe, poignée papillon aluminium rouge.



ACS

Codice Code	Misura Size Dimensions	PN	Volume	Weight
1200T 015	1/2"	25	25	100
1200T 020	3/4"	20	20	80
1200T 025	1"	12	12	48

1150 M

VALVOLA A SFERA SERIE STRONG IN OTTONE NICHELATO, A PASSAGGIO TOTALE, FILETTATURA F/F, CON PREMISTOPPA. MANIGLIA A T PROLUNGATA.

Full way ball valve F/F, STRONG series, made of brass, nickel plated, with stuffing box. With extended T handle.

Vanne à boisseau sphérique, série STRONG, en laiton nickelé, passage intégral F/F à presse étoupe, poignée à T.



ACS

Codice Code	Misura Size Dimensions	PN	Volume	Weight
1150M 015	1/2"	40	25	100
1150M 020	3/4"	40	15	60
1150M 025	1"	40	12	48
1150M 032 *	1 1/4"	30	6	24
1150M 040 *	1 1/2"	30	3	12
1150M 050 *	2"	30	1	12

1200 M

VALVOLA A SFERA SERIE STRONG IN OTTONE NICHELATO, A PASSAGGIO TOTALE, FILETTATURA M/F, CON PREMISTOPPA. MANIGLIA A T PROLUNGATA.

Full way ball valve M/F, STRONG series, made of brass, nickel plated, with stuffing box. With extended T handle.

Vanne à boisseau sphérique, série STRONG, en laiton nickelé, passage intégral M/F à presse étoupe, poignée à T.



ACS

Codice Code	Misura Size Dimensions	PN	Volume	Weight
1200M 015	1/2"	40	25	100
1200M 020	3/4"	40	15	60
1200M 025	1"	40	12	48
1200M 032 *	1 1/4"	30	6	24
1200M 040 *	1 1/2"	30	3	12
1200M 050 *	2"	30	1	12

1340 T

VALVOLA A SFERA M/F A PASSAGGIO TOTALE SERIE STRONG, IN OTTONE NICHELATO FILETTATURA FEMMINA, CON RACCORDO PER COLLETTORI. FARFALLA ALLUMINIO ROSSA.

Full way ball valve M/F, STRONG series, made of brass, nickel plated, with tail for manifold. Aluminium red butterfly handle.

Vanne à boisseau sphérique, série STRONG, passage intégral M/F, filetage F avec raccord pour collecteurs, poignée papillon aluminium rouge.



ACS

Codice Code	Misura Size Dimensions	PN	Volume	Weight
1340T 015	1/2"	20	20	80
1340T 020	3/4"	15	15	60
1340T 025	1"	8	8	32

1370 T

VALVOLA A SFERA M/F A PASSAGGIO TOTALE, SERIE HEAVY IN OTTONE NICHELATO AD ANGOLO, FILETTATURA FEMMINA, CON RACCORDO PER COLLETTORI. FARFALLA ALLUMINIO ROSSA.

Angle full way ball valve M/F, HEAVY series, made of brass, nickel plated, with tail for manifold. Aluminium red butterfly handle.

Vanne à boisseau sphérique, série HEAVY, passage intégral M/F à équerre, filetage F avec raccord pour collecteurs, poignée papillon aluminium rouge.



PN 16

ACS

Codice Code	Misura Size Dimensions	PN	Volume	Weight
1370T 015	1/2"	25	25	100
1370T 020	3/4"	15	15	60
1370T 025	1"	9	9	36

SERIE **BIG** Series Série

VALVOLA A SFERA, SERIE BIG, A PASSAGGIO TOTALE IN OTTONE STAMPATO, SABBIA TO E NICHELATO.

- ASTA IN OTTONE CON PREMISTOPPA, MONTATA DALL'INTERNO CONTRO LE MANOMISSIONI E/O L'ESTRAZIONE E ANTISCOPPIO
- SFERA IN OTTONE DIAMANTATA E CROMATA
- SEDI IN PTFE
- DOPPIA TENUTA OR + PTFE
- LEVA IN: ALLUMINIO [SERIE T] O IN ACCIAIO ZINCATO CON RIVESTIMENTO IN PVC [SERIE ST]
- FILETTATURE SECONDO ISO 228/1
- LIMITI DI PRESSIONE 30 BAR (PN 30)
- LIMITI DI TEMPERATURA -20 +130 °C

Full way ball valve, BIG series, made of forged brass, sand-blasted and nickel plated.

- Brass stem with stuffing box assembled from inside to avoid tampering, extraction or explosion
- Brass solid ball with cleaned and chromium plated surface
- PTFE seats
- Double seal OR + PTFE
- Lever made of aluminium [T series] or made of steel with PVC coating [ST series]
- Threads according to ISO 228/1
- Pressure limits 30 bar (PN 30)
- Temperature range -20 +130 °C

Vanne à boisseau sphérique, série BIG, en laiton matricé, sablé et nickelé, passage intégral.

- Tige en laiton avec presse étoupe montée de l'intérieur contre les altérations et/ou l'extraction et anti éclat
- Sphère diamantée et chromée
- Sièges en PTFE
- Double joint OR + PTFE
- Poignée: en aluminium [série T] ou en acier avec revêtement en PVC [série ST]
- Filetages selon ISO 228/1
- Limites de pression 30 bar (PN 30)
- Limites de température -20 +130 °C

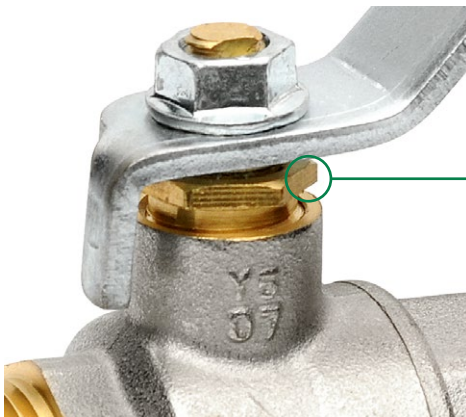
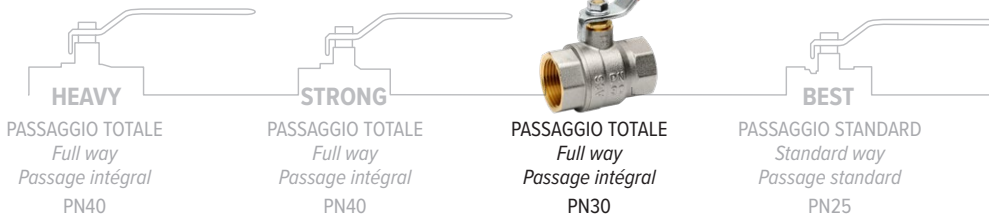

PREMISTOPPA *Stuffing box Presse étoupe*

1050 ST

VALVOLA A SFERA SERIE BIG IN OTTONE NICHELATO, A PASSAGGIO TOTALE, FILETTATURA F/F, CON PREMISTOPPA. LEVA PIATTA ROSSA IN ACCIAIO.

Full way ball valve F/F, BIG series, made of brass, nickel plated, with stuffing box. Red flat steel lever.

Vanne à boisseau sphérique, série BIG, en laiton nickelé, passage intégral F/F à presse étoupe, poignée acier rouge.



FORO HOLE ANTILEGIONELLA

ACS PED2014/68/UE 1370

Codice Code	Misura Size	Dimensions	PN	☐	📦
1050ST 008	1/4"		40	40	160
1050ST 010	3/8"		40	40	160
1050ST 015	1/2"		30	30	120
1050ST 020	3/4"		30	25	100
1050ST 025	1"		30	15	60
1050ST 032 *	1 1/4"		30	8	32
1050ST 040 *	1 1/2"		30	4	16
1050ST 050 *	2"		30	1	15
1050ST 065 *	2 1/2"		25	1	8
1050ST 080 *	3"		16	1	6
1050ST 100 *	4"		16	1	4

1100 ST

VALVOLA A SFERA SERIE BIG IN OTTONE NICHELATO, A PASSAGGIO TOTALE, FILETTATURA M/F. LEVA PIATTA ROSSA IN ACCIAIO.

Full way ball valve M/F, BIG series, made of brass, nickel plated. Red flat steel lever.

Vanne à boisseau sphérique, série BIG, en laiton nickelé, passage intégral M/F, poignée acier rouge.



FORO HOLE ANTILEGIONELLA

ACS PED2014/68/UE 1370

Codice Code	Misura Size	Dimensions	PN	☐	📦
1100ST 008	1/4"		40	40	160
1100ST 010	3/8"		40	40	160
1100ST 015	1/2"		30	30	120
1100ST 020	3/4"		30	25	100
1100ST 025	1"		30	15	60
1100ST 032 *	1 1/4"		30	8	32
1100ST 040 *	1 1/2"		30	4	16
1100ST 050 *	2"		30	1	15

1050 T

VALVOLA A SFERA SERIE BIG IN OTTONE NICHELATO, A PASSAGGIO TOTALE, FILETTATURA F/F, CON PREMISTOPPA. FARFALLA ALLUMINIO ROSSA.

Full way ball valve F/F, BIG series, made of brass, nickel plated, with stuffing box. Red aluminium butterfly handle.

Vanne à boisseau sphérique, série BIG, en laiton nickelé, passage intégral F/F à presse étoupe, poignée papillon aluminium rouge.



ACS

Codice Code	Misura Size Dimensions	PN	☐	📦
1050T 008 ☒	1/4"	40	40	160
1050T 010 ☒	3/8"	40	40	160
1050T 015 ☒	1/2"	30	35	140
1050T 020 ☒	3/4"	30	25	100
1050T 025 ☒	1"	30	15	60

1100 T

VALVOLA A SFERA SERIE BIG IN OTTONE NICHELATO, A PASSAGGIO TOTALE, FILETTATURA M/F, FARFALLA ALLUMINIO ROSSA.

Full way ball valve M/F, BIG series, made of brass, nickel plated. Red aluminium butterfly handle.

Vanne à boisseau sphérique, série BIG, en laiton nickelé, passage intégral M/F, poignée papillon aluminium rouge.



ACS

Codice Code	Misura Size Dimensions	PN	☐	📦
1100T 008 ☒	1/4"	40	40	160
1100T 010 ☒	3/8"	40	40	160
1100T 015 ☒	1/2"	30	35	140
1100T 020 ☒	3/4"	30	25	100
1100T 025 ☒	1"	30	15	60

1350 T

VALVOLA A SFERA IN OTTONE NICHELATO, A PASSAGGIO STANDARD, FILETTATURA M/F, CON RACCORDO PER COLLETTORI. FARFALLA ALLUMINIO ROSSA.

Standard way ball valve M/F, made of brass, nickel plated, with tail for manifold. Red aluminium butterfly handle.

Vanne à boisseau sphérique, en laiton nickelé, passage standard M/F, avec raccord pour collecteurs, poignée papillon aluminium rouge.

PN 16
LIMITI DI TEMPERATURA -20 +120 °C
Temperat. limits Limites de température



ACS

Codice Code	Misura Size Dimensions	☐	📦
1350T 015	1/2"	25	100
1350T 020	3/4"	15	60
1350T 025	1"	12	48
1350T 032	1 1/4"	8	32

1370 T

VALVOLA A SFERA M/F A PASSAGGIO TOTALE, SERIE HEAVY IN OTTONE NICHELATO AD ANGOLO, FILETTATURA FEMMINA, CON RACCORDO PER COLLETTORI. FARFALLA ALLUMINIO ROSSA.

Angle full way ball valve M/F, HEAVY series, made of brass, nickel plated, with tail for manifold. Aluminium red butterfly handle.

Vanne à boisseau sphérique, série HEAVY, laiton nickelé, passage intégral M/F à équerre, filetage F avec raccord pour collecteurs, poignée papillon aluminium rouge.



PN 16

ACS

Codice Code	Misura Size Dimensions	☐	📦
1370T 015	1/2"	25	100
1370T 020	3/4"	15	60
1370T 025	1"	9	36

1800

VALVOLA A SFERA SERIE BIG IN OTTONE NICHELATO, A PASSAGGIO TOTALE, FILETTATURA F/F, CON CAPPUCCIO PIOMBABILE IN OTTONE.

Full way ball valve F/F, BIG series, made of brass, nickel plated. With brass locking cap.

Vanne à boisseau sphérique, série BIG, en laiton nickelé, passage intégral F/F avec capuchon plombable en laiton.



CE 1370
PED2014/68/UE

Codice Code	Misura Size Dimensions	☐	☐	📦
1800 015 ☒	1/2"	20	35	140
1800 020 ☒	3/4"	20	25	100
1800 025 ☒	1"	23	15	60
1800 032 *	1 1/4"	23	8	32
1800 040 *	1 1/2"	26	6	24
1800 050 *	2"	26	1	15

1810

VALVOLA A SFERA SERIE BIG IN OTTONE NICHELATO, A PASSAGGIO TOTALE, FILETTATURA M/F, CON CAPPUCCIO PIOMBABILE IN OTTONE.

Full way ball valve M/F, BIG series, made of brass, nickel plated. With brass locking cap.

Vanne à boisseau sphérique, série BIG, en laiton nickelé, passage intégral M/F avec capuchon plombable en laiton.



CE 1370
PED2014/68/UE

Codice Code	Misura Size Dimensions	☐	☐	📦
1810 015 ☒	1/2"	20	35	140
1810 020 ☒	3/4"	20	25	100
1810 025 ☒	1"	23	15	60
1810 032 *	1 1/4"	23	8	32
1810 040 *	1 1/2"	26	6	24
1810 050 *	2"	26	1	15

1050 M

VALVOLA A SFERA SERIE BIG IN OTTONE NICHELATO, A PASSAGGIO TOTALE, FILETTATURA F/F, CON PREMISTOPPA. MANIGLIA A T PROLUNGATA.

Full way ball valve F/F, BIG series, made of brass, nickel plated, with stuffing box. With extended T handle.

Vanne à boisseau sphérique, série BIG, en laiton nickelé, passage intégral F/F à presse étoupe, poignée à T.



Codice Code	Misura Size Dimensions		
1050M 010	3/8"	35	140
1050M 015	1/2"	30	120
1050M 020	3/4"	20	80
1050M 025	1"	12	48
1050M 032 *	1"1/4	6	24
1050M 040 *	1"1/2	4	16
1050M 050 *	2"	1	12

1100 M

VALVOLA A SFERA SERIE BIG IN OTTONE NICHELATO, A PASSAGGIO TOTALE, FILETTATURA M/F, MANIGLIA A T PROLUNGATA.

Full way ball valve M/F, BIG series, made of brass, nickel plated. With extended T handle.

Vanne à boisseau sphérique, série BIG, en laiton nickelé, passage intégral M/F, poignée à T.



Codice Code	Misura Size Dimensions		
1100M 010	3/8"	35	140
1100M 015	1/2"	30	120
1100M 020	3/4"	20	80
1100M 025	1"	12	48
1100M 032 *	1"1/4	6	24
1100M 040 *	1"1/2	4	16
1100M 050 *	2"	1	12

1330 ST

VALVOLA A SFERA A PASSAGGIO TOTALE CON RACCORDI A COMPRESIONE PER TUBO RAME, BS EN 1254. CON PREMISTOPPA. LEVA PIATTA ROSSA IN ACCIAIO.

Full way ball valve with compression ends for copper pipe, to BS EN 1254, made of brass, chrome plated. With stuffing box. Red flat steel lever.

Vanne à boisseau sphérique, passage intégral avec raccords à compression pour tube CU, BS EN 1254, à presse étoupe. Poignée acier rouge.



PN 16

Codice Code	Misura Size Dimensions		
1330ST 015	15 mm	20	80
1330ST 018	18 mm	20	80
1330ST 022	22 mm	15	60
1330ST 028	28 mm	10	40
1330ST 035	35 mm	4	16

1330 T

VALVOLA A SFERA A PASSAGGIO TOTALE CON RACCORDI A COMPRESIONE PER TUBO RAME, BS EN 1254. CON PREMISTOPPA. FARFALLA ALLUMINIO ROSSA.

Full way ball valve with compression ends for copper pipe, to BS EN 1254, made of brass, chrome plated. With stuffing box. Red aluminium butterfly handle.

Vanne à boisseau sphérique, passage intégral avec raccords à compression pour tube CU, BS EN 1254, à presse étoupe. Poignée papillon aluminium rouge.



PN 16

Codice Code	Misura Size Dimensions		
1330T 015	15 mm	25	100
1330T 018	18 mm	20	80
1330T 022	22 mm	15	60
1330T 028	28 mm	10	40
1330T 035	35 mm	5	20

1410 ST

VALVOLA A SFERA F/F IN OTTONE NICHELATO PASSAGGIO TOTALE CON VALVOLA DI SPURGO, CON PREMISTOPPA. LEVA PIATTA ROSSA IN ACCIAIO.

Full way ball valve drain-off valve, made of brass, nickel plated, with stuffing box. Red flat steel lever.

Vanne à boisseau sphérique en laiton nickelé F/F, passage intégral, avec purgeur, à presse étoupe. Poignée acier rouge.



ACS

PN 16

Codice Code	Misura Size Dimensions		
1410ST 015	1/2"	20	80
1410ST 020	3/4"	15	60
1410ST 025	1"	10	40
1410ST 032	1"1/4	4	24
1410ST 040	1"1/2	1	15
1410ST 050	2"	1	12

1410 M

VALVOLA A SFERA F/F IN OTTONE NICHELATO PASSAGGIO TOTALE CON VALVOLA DI SPURGO. MANIGLIA A T PROLUNGATA.

Full way ball valve drain-off valve, made of brass, nickel plated. With extended T handle.

Vanne à boisseau sphérique en laiton nickelé F/F, passage intégral, avec purgeur, poignée à T.



ACS

PN 16

Codice Code	Misura Size Dimensions		
1410M 015	1/2"	15	60
1410M 020	3/4"	12	48
1410M 025	1"	10	40
1410M 032	1"1/4	5	20
1410M 040	1"1/2	1	12
1410M 050	2"	1	12

1348 T

VALVOLA A SFERA CON PREMISTOPPA M/F, CON CALOTTA MOBILE 1"x1". FARFALLA ALLUMINIO ROSSA.

Full way ball valve M/F 1"x1" with swivel end, with stuffing box. Red aluminium butterfly handle.

Vanne à boisseau sphérique M/F 1"x1", à presse étoupe. Poignée papillon aluminium rouge.



Codice Code	Misura Size Dimensions		
1348T 025	M 1" x F 1"	15	60

1450 T

VALVOLA A SFERA CON FILTRO Y IN OTTONE NICHELATO, FILETTATURA F/F CON PREMISTOPPA. FARFALLA ALLUMINIO ROSSA.

Ball valve F/F with Y strainer made of brass nickel plated with stuffing box. Red aluminium butterfly handle.

Vanne à boisseau sphérique avec filtre d'impureté en Y en laiton nickelé, filetage F/F à presse étoupe. Poignée papillon rouge.



PN 20

Codice Code	Misura Size Dimensions		
1450T 015	1/2"	20	80
1450T 020	3/4"	15	60
1450T 025	1"	8	32

1420 T

VALVOLA A SFERA CON ATTACCO PORTA SONDA PIOMBABILE IN OTTONE NICHELATO, FILETTATURA F/F CON PREMISTOPPA. FARFALLA ALLUMINIO ROSSA.

Ball valve with sealable probe holder made of brass nickel plated with stuffing box. Red aluminium butterfly handle.

Vanne à boisseau sphérique avec porte-sonde plombable en laiton nickelé, filetage F/F à presse étoupe. Poignée papillon rouge.



Codice Code	Misura Size Dimensions		
1420T 015	1/2"	25	100
1420T 020	3/4"	20	80
1420T 025	1"	12	48

1425 T

VALVOLA A SFERA CON RACCORDO PER COLLETTORI ED ATTACCO PORTA SONDA PIOMBABILE IN OTTONE NICHELATO, FILETTATURA M/F CON PREMISTOPPA. FARFALLA ALLUMINIO ROSSA.

Ball valve M/F with sealable probe holder and tail for manifold made of brass nickel plated with stuffing box. Red aluminium butterfly handle.

Vanne à boisseau sphérique avec porte-sonde plombable en laiton nickelé, filetage M/F à presse étoupe. Poignée papillon rouge.



Codice Code	Misura Size Dimensions		
1425T 020	M3/4"xF3/4"	15	60

1428 T

VALVOLA A SFERA CON CALOTTA LIBERA F/F ED ATTACCO PORTA SONDA PIOMBABILE IN OTTONE NICHELATO, FILETTATURA F/F CON PREMISTOPPA. FARFALLA ALLUMINIO ROSSA.

Ball valve F/F with swivel end and tail for manifold made of brass nickel plated with stuffing box. Red aluminium butterfly handle.

Vanne à boisseau sphérique avec porte-sonde plombable en laiton nickelé, filetage F/F à presse étoupe. Poignée papillon rouge.



Codice Code	Misura Size Dimensions		
1428T 020	M3/4"xF3/4"	15	60

SERIE BEST Series Série

VALVOLA A SFERA, SERIE BEST, A PASSAGGIO STANDARD IN OTTONE STAMPATO, SABBBIATO E NICHELATO.

- ASTA IN OTTONE CON PREMISTOPPA, MONTATA DALL'INTERNO CONTRO LE MANOMISSIONI E/O L'ESTRAZIONE E ANTISCOPIO
- SFERA IN OTTONE DIAMANTATA E CROMATA
- SEDI IN PTFE
- DOPPIA TENUTA OR + PTFE
- LEVA IN: ALLUMINIO [SERIE T] O IN ACCIAIO ZINCATO CON RIVESTIMENTO IN PVC [SERIE ST]
- FILETTATURE SECONDO ISO 228/1
- LIMITI DI PRESSIONE 25 BAR (PN 25)
- LIMITI DI TEMPERATURA -20 +130 °C

Standard way ball valve, BEST series, made of forged brass, sand-blasted and nickel plated.

- Brass stem with stuffing box assembled from inside to avoid tampering, extraction or explosion
- Brass solid ball with cleaned and chromium plated surface
- PTFE seats
- Double seal OR + PTFE
- Lever made of aluminium [T series] or made of steel with PVC coating [ST series]
- Threads according to ISO 228/1
- Pressure limits 25 bar (PN 25)
- Temperature range -20 +130 °C

Vanne à boisseau sphérique, série BEST, en laiton matricé, sablé et nickelé, passage standard.

- Tige en laiton avec presse étoupe montée de l'intérieur contre les altérations et/ou l'extraction et anti éclat
- Sphère diamantée et chromée
- Sièges en PTFE
- Double joint OR + PTFE
- Poignée: en aluminium [série T] ou en acier avec revêtement en PVC [série ST]
- Filetages selon ISO 228/1
- Limites de pression 25 bar (PN 25)
- Limites de température -20 +130 °C

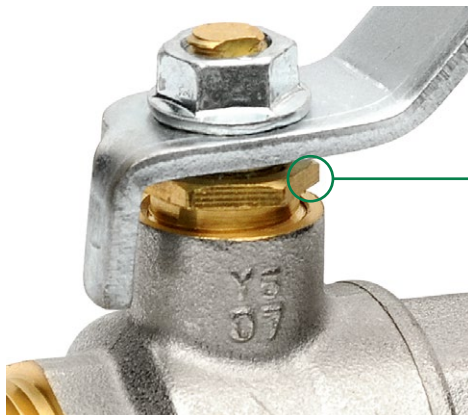
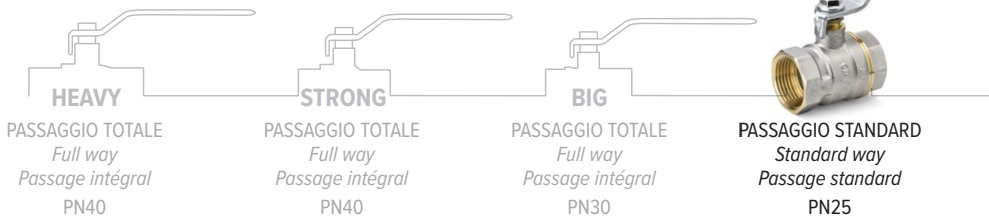

PREMISTOPPA *Stuffing box Presse étoupe*

1030 ST

VALVOLA A SFERA SERIE BEST IN OTTONE NICHELATO, A PASSAGGIO STANDARD, FILETTATURA F/F, CON PREMISTOPPA. LEVA PIATTA ROSSA IN ACCIAIO.

Standard way ball valve F/F, BEST series, made of brass, nickel plated, with stuffing box. Red flat steel lever.

Vanne à boisseau sphérique, série BEST, en laiton nickelé, passage standard F/F à presse étoupe, poignée acier rouge.



Codice Code	Misura Size Dimensions	PN		
1030ST 010	3/8"	25	50	200
1030ST 015	1/2"	25	30	120
1030ST 020	3/4"	25	25	100
1030ST 025	1"	25	15	60
1030ST 032 *	1 1/4"	25	9	36
1030ST 040 *	1 1/2"	25	6	24
1030ST 050 *	2"	25	3	12
1050ST 065 *	2 1/2"	25	1	8
1050ST 080 *	3"	16	1	6
1050ST 100 *	4"	16	1	4

1130 ST

VALVOLA A SFERA SERIE BEST IN OTTONE NICHELATO, A PASSAGGIO STANDARD, FILETTATURA M/F. LEVA PIATTA ROSSA IN ACCIAIO.

Standard way ball valve M/F, BEST series, made of brass, nickel plated. Red flat steel lever.

Vanne à boisseau sphérique, série BEST, en laiton nickelé, passage standard M/F, poignée acier rouge.



Codice Code	Misura Size Dimensions		
1130ST 010	3/8"	50	200
1130ST 015	1/2"	30	120
1130ST 020	3/4"	25	100
1130ST 025	1"	15	60
1130ST 032 *	1 1/4"	9	36
1130ST 040 *	1 1/2"	6	24
1130ST 050 *	2"	3	12

1030 T

VALVOLA A SFERA SERIE BEST IN OTTONE NICHELATO, A PASSAGGIO STANDARD, FILETTATURA F/F, CON PREMISTOPPA. FARFALLA ALLUMINIO ROSSA.

Standard way ball valve F/F, BEST series, made of brass, nickel plated, with stuffing box. Red aluminium butterfly handle.

Vanne à boisseau sphérique, série BEST, en laiton nickelé, passage standard F/F à presse étoupe, poignée papillon aluminium rouge.



Codice Code	Misura Size Dimensions	☐	📦
1030T 010	3/8"	60	240
1030T 015	1/2"	40	160
1030T 020	3/4"	25	100
1030T 025	1"	20	80
1030T 032 *	1"1/4	9	36

1130 T

VALVOLA A SFERA SERIE BEST IN OTTONE NICHELATO, A PASSAGGIO STANDARD, FILETTATURA M/F. FARFALLA ALLUMINIO ROSSA.

Standard way ball valve M/F, BEST series, made of brass, nickel plated. Red aluminium butterfly handle.

Vanne à boisseau sphérique, série BEST, en laiton nickelé, passage standard M/F, poignée papillon aluminium rouge.



Codice Code	Misura Size Dimensions	☐	📦
1130T 010	3/8"	60	240
1130T 015	1/2"	40	160
1130T 020	3/4"	25	100
1130T 025	1"	20	80
1130T 032 *	1"1/4	9	36

1230 ST

VALVOLA A SFERA SERIE BEST IN OTTONE NICHELATO, A PASSAGGIO STANDARD, FILETTATURA M/M. LEVA PIATTA ROSSA IN ACCIAIO.

Standard way ball valve M/M, BEST series, made of brass, nickel plated. Red flat steel lever.

Vanne à boisseau sphérique, série BEST, en laiton nickelé, passage standard M/M, poignée acier rouge.



Codice Code	Misura Size Dimensions	☐	📦
1230ST 010	3/8"	50	200
1230ST 015	1/2"	30	120
1230ST 020	3/4"	25	100
1230ST 025	1"	15	60
1230ST 032 *	1"1/4	9	36
1230ST 040 *	1"1/2	6	24
1230ST 050 *	2"	3	12

1230 T

VALVOLA A SFERA SERIE BEST IN OTTONE NICHELATO, A PASSAGGIO STANDARD, FILETTATURA M/M. FARFALLA ALLUMINIO ROSSA.

Standard way ball valve M/M, BEST series, made of brass, nickel plated. Red aluminium butterfly handle.

Vanne à boisseau sphérique, série BEST, en laiton nickelé, passage standard M/M, poignée papillon aluminium rouge.



Codice Code	Misura Size Dimensions	☐	📦
1230T 010	3/8"	60	240
1230T 015	1/2"	40	160
1230T 020	3/4"	25	100
1230T 025	1"	20	80
1230T 032 *	1"1/4	9	36

1030 M

VALVOLA A SFERA SERIE BEST IN OTTONE NICHELATO, A PASSAGGIO STANDARD, FILETTATURA F/F, CON PREMISTOPPA. MANIGLIA A T PROLUNGATA.

Standard way ball valve F/F, BEST series, made of brass, nickel plated, with stuffing box. With extended T handle.

Vanne à boisseau sphérique, série BEST, en laiton nickelé, passage standard F/F à presse étoupe, poignée à T.



Codice Code	Misura Size Dimensions	☐	📦
1030M 015	1/2"	30	120
1030M 020	3/4"	25	100
1030M 025	1"	12	48
1030M 032 *	1"1/4	6	24
1030M 040 *	1"1/2	4	16
1030M 050 *	2"	1	12

1130 M

VALVOLA A SFERA SERIE BEST IN OTTONE NICHELATO, A PASSAGGIO STANDARD, FILETTATURA M/F. MANIGLIA A T PROLUNGATA.

Standard way ball valve M/F, BEST series, made of brass, nickel plated. With extended T handle.

Vanne à boisseau sphérique, série BEST, en laiton nickelé, passage standard M/F, poignée à T.



Codice Code	Misura Size Dimensions	☐	📦
1130M 015	1/2"	30	120
1130M 020	3/4"	25	100
1130M 025	1"	12	48
1130M 032 *	1"1/4	6	24
1130M 040 *	1"1/2	4	16
1130M 050 *	2"	1	12

1060 I

VALVOLA A SFERA F/F IN OTTONE NICHELATO, COLLO LUNGO PER TUBAZIONI CON ISOLAMENTO TERMICO.

Ball valve long neck F/F w/lever suitable for pipes insulation, made of brass, nickel plated.

Vanne à boisseau sphérique F/F en laiton nickelé, col rallongé.

PN 20



Codice Code	Misura Size	Dimensions		
1060I 015	1/2"		20	80
1060I 020	3/4"		15	60
1060I 025	1"		10	40
1060I 032	1" 1/4		6	24
1060I 040	1" 1/2		4	16
1060I 050	2"		2	8

PRLE

PROLUNGA DI MANOVRA PER ISOLAMENTO TERMICO.

Handle extension for thermal insulation.

Extension de la tige pour l'isolation thermique.



Codice Code		
PRLE 1 MIS	50	200
PRLE 2 MIS	40	160
PRLE 3 MIS	25	100

DISPONIBILE PER TUTTE LE SERIE

Suitable for all series

Convient pour toutes les séries

HEAVY / STRONG / BIG / BEST

TABELLA DI COMPATIBILITÀ COMPATIBILITY CHART TABLEAU DE COMPATIBILITÉ

Misura Size Dimensions	HEAVY 1170/1220	STRONG 1150/1200	BIG 1050/1100	BEST 1030/1130/1230
1/4"			PRLE1MIS	
3/8"			PRLE1MIS	PRLE1MIS
1/2"	PRLE1MIS	PRLE1MIS	PRLE1MIS	PRLE1MIS
3/4"	PRLE1MIS	PRLE1MIS	PRLE1MIS	PRLE1MIS
1"	PRLE2MIS	PRLE2MIS	PRLE2MIS	PRLE2MIS
1" 1/4	PRLE2MIS	PRLE2MIS	PRLE2MIS	PRLE2MIS
1" 1/2	PRLE3MIS	PRLE3MIS	PRLE3MIS	PRLE3MIS
2"	PRLE3MIS	PRLE3MIS	PRLE3MIS	PRLE3MIS

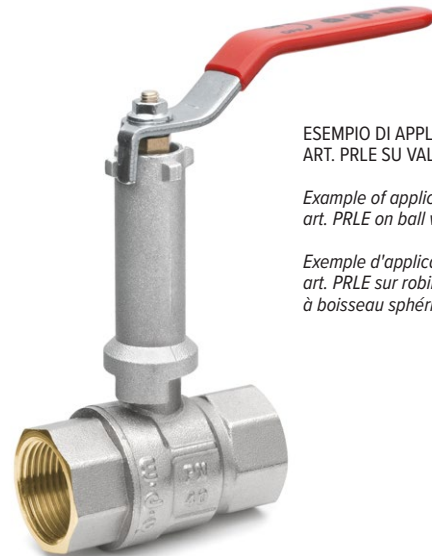

ESEMPIO DI APPLICAZIONE
ART. PRLE SU VALVOLA A SFERA

*Example of application
art. PRLE on ball valve*

*Exemple d'application
art. PRLE sur robinet
à boisseau sphérique*

SERIE STRONG DZR *Series Série*

VALVOLA A SFERA, SERIE STRONG, A PASSAGGIO TOTALE IN OTTONE DZR STAMPATO, SABBIAITO.

- ASTA IN OTTONE CON PREMISTOPPA, MONTATA DALL'INTERNO CONTRO LE MANOMISSIONI E/O L'ESTRAZIONE E ANTISCOPPIO
- SFERA IN OTTONE DIAMANTATA E CROMATA
- SEDI IN PTFE
- LEVA IN: IN ACCIAIO ZINCATO CON RIVESTIMENTO IN PVC [SERIE ST]
- FILETTATURE SECONDO ISO 228
- LIMITI DI PRESSIONE 40 BAR (PN 40)
- LIMITI DI TEMPERATURA -20 +130 °C

Full way ball valve, STRONG series, made of DZR forged brass, sand-blasted.

- Brass stem with stuffing box assembled from inside to avoid tampering, extraction or explosion
- Brass solid ball with cleaned and chromium plated surface
- PTFE seats
- Lever made of steel with PVC coating [ST series]
- Threads according to ISO 228
- Pressure limits 40 bar (PN 40)
- Temperature range -20 +130 °C

Vanne à boisseau sphérique, série STRONG, en DZR laiton matricé, sablé, passage intégral.

- Tige en laiton avec presse étoupe montée de l'intérieur contre les altérations et/ou l'extraction et anti éclat
- Sphère diamantée et chromée
- Sièges en PTFE
- Poignée: en acier avec revêtement en PVC [série ST]
- Filetages selon ISO 228
- Limites de pression 40 bar (PN 40)
- Limites de température -20 +130 °C

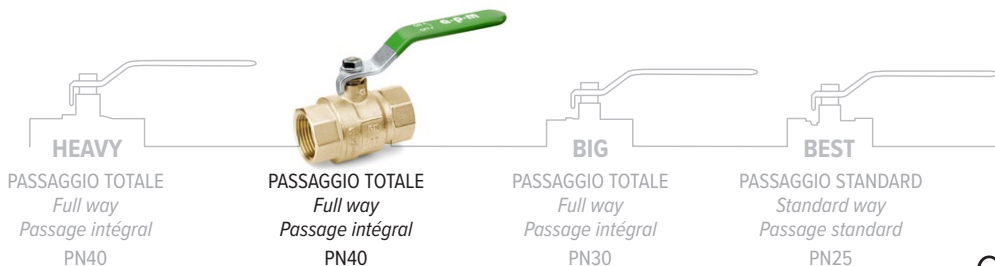

HEAVY
PASSAGGIO TOTALE
Full way
Passage intégral
PN40

PASSAGGIO TOTALE
Full way
Passage intégral
PN40

BIG
PASSAGGIO TOTALE
Full way
Passage intégral
PN30

BEST
PASSAGGIO STANDARD
Standard way
Passage standard
PN25

PREMISTOPPA *Stuffing box Presse étoupe*

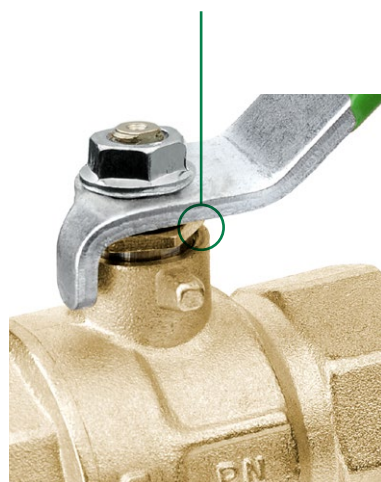

Le valvole a sfera della serie STRONG DZR realizzato in ottone "speciale" formato da una lega di rame e zinco, appositamente creata per resistere alla corrosione ed evitare il distacco dello zinco e il suo deposito sulle sedi di chiusura della valvola. Questo processo, detto "fenomeno elettrolitico", può causare il malfunzionamento della valvola stessa.

The ball valves of the STRONG DZR series made with a "special" brass made of a copper alloy and zinc, specially designed to withstand corrosion and avoid zinc release and his repositioning on the closing seats of the valve. This process, called "electrolytic phenomenon" can cause the valve malfunction same.

Les vannes à sphère de la série STRONG DZR fait avec un laiton "spécial" formé de une alliage de cuivre et zinc, spécialement crée pour résister à la corrosion et éviter le détachement du zinc et son repositionnement sur les sièges de fermeture de la vanne. Ce processus, appelé "phénomène électrolytique" peut causer les dysfonctionnement de la même -vanne.

OTTONE DZR *Brass Laiton*



è adatto a resistere alle acque marine e salmastre
is suitable to withstand marine and brackish waters est approprié à résister aux eaux marines et saumâtres



è adatto a resistere ai cloruri presenti nell'acqua potabile
is suitable to withstand chlorides present in drinking water est approprié à résister aux les chlorures présents dans l'eau potable



è adatto a resistere alle acque dure
is suitable to withstand hard water est approprié à résister aux eaux dures



è adatto a resistere alle acque ricche di anidride carbonica disciolta
is suitable to withstand water rich in dissolved carbon dioxide est approprié à résister aux eaux riches de dioxyde de carbone dissous



è adatto a resistere alle acque con alto potere conduttivo
is suitable to withstand waters with high conductive power est approprié à résister aux eaux avec haute pouvoir de conduction

1154 STV

VALVOLA A SFERA SERIE STRONG IN OTTONE DZR, A PASSAGGIO TOTALE, FILETTATURA F/F. LEVA PIATTA VERDE IN ACCIAIO.

Full way ball valve F/F, STRONG series, made of DZR brass. Green flat steel lever.

Vanne à boisseau sphérique, série STRONG, en DZR laiton, passage intégral F/F. Poignée acier vert.



DZR
*CE 1370
PED2014/68/UE

Codice Code	Misura Size	Dimensions	PN	☐	⊠
1154STV 015		1/2"	40	25	100
1154STV 020		3/4"	40	20	80
1154STV 025		1"	40	12	48
1154STV 032 *		1"1/4	30	8	32
1154STV 040 *		1"1/2	30	4	16
1154STV 050 *		2"	30	1	12

1204 STV

VALVOLA A SFERA SERIE STRONG IN OTTONE DZR, A PASSAGGIO TOTALE, FILETTATURA M/F. LEVA PIATTA VERDE IN ACCIAIO.

Full way ball valve M/F, STRONG series, made of DZR brass. Green flat steel lever.

Vanne à boisseau sphérique, série STRONG, en DZR laiton, passage intégral M/F. Poignée acier vert.



Codice Code	Misura Size	Dimensions	☐	⊠
1204STV 015		1/2"	25	100
1204STV 020		3/4"	20	80
1204STV 025		1"	12	48

DZR

VALVOLE AVANT-CONTATORE

Ball valve for **water meter**

Vanne à sphère pour **compteur d'eau**

VALVOLA A SFERA IN OTTONE STAMPATO E SABBIAATO.

- ASTA IN OTTONE MONTATA DALL'INTERNO CONTRO LE MANOMISSIONI E/O L'ESTRAZIONE E ANTI SCOPPIO
- TENUTA O-RINGS NBR
- SEDI IN PTFE
- LEVA IN OTTONE
- FILETTATURE SECONDO UNI ISO 228/1
- LIMITI DI PRESSIONE 25 BAR (PN 25)
- LIMITI DI TEMPERATURA -20 +120 °C

Ball valve in forged and sandblasted brass.

- Brass rod mounted from the inside anti-tampering and/or extraction and anti-burst
- NBR O-ring seal
- PTFE seats
- Brass lever
- Threads according to UNI ISO 228/1
- Pressure limits 25 bar (PN 25)
- Temperature range -20 +120 °C

Robinet sphérique en laiton forgé et sablé.

- Tige en laiton montée de l'intérieur anti-effraction et/ou extraction et anti-éclatement
- Joint torique NBR
- Sièges PTFE
- Poignée en laiton
- Filetages selon UNI ISO 228/1
- Limites de pression 25 bar (PN 25)
- Limites de température -20 +120 °C

1040

VALVOLA A SFERA AVANT-CONTATORE, DRITTA FEMMINA - CALOTTA LIBERA.

Brass ball valve for water meter, Female straight - Swivel nut.

Vanne à sphère en laiton pour compteur d'eau - Droite femelle avec écrou prisonnier.



ACS

Codice Code	Misura Size Dimensions	☐	📦
1040 01520	F 1/2" x F 3/4"	20	80
1040 02020	F 3/4" x F 3/4"	20	80

1041

VALVOLA A SFERA AVANT-CONTATORE, DRITTA MASCHIO - CALOTTA LIBERA.

Brass ball valve for water meter, Male straight - Swivel nut.

Vanne à sphère en laiton pour compteur d'eau - Droite mâle avec écrou prisonnier.

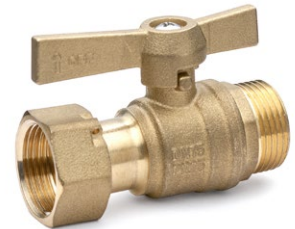

ACS

Codice Code	Misura Size Dimensions	☐	📦
1041 01520	M 1/2" x F 3/4"	20	80
1041 02020	M 3/4" x F 3/4"	20	80

1042

VALVOLA A SFERA AVANT-CONTATORE, ANGOLO FEMMINA - CALOTTA LIBERA.

Brass ball valve for water meter, Female angle - Swivel nut.

Vanne à sphère en laiton pour compteur d'eau - Équerre femelle avec écrou prisonnier.



ACS

Codice Code	Misura Size Dimensions	☐	📦
1042 01520	F 1/2" x F 3/4"	20	80
1042 02020	F 3/4" x F 3/4"	20	80

1043

VALVOLA A SFERA AVANT-CONTATORE, ANGOLO MASCHIO - CALOTTA LIBERA.

Brass ball valve for water meter, Male angle - Swivel nut.

Vanne à sphère en laiton pour compteur d'eau - Équerre mâle avec écrou prisonnier.



ACS

Codice Code	Misura Size Dimensions	☐	📦
1043 01520	M 1/2" x F 3/4"	20	80
1043 02020	M 3/4" x F 3/4"	20	80

SCARICO CALDAIA

Boiler drain-off

Robinet purgeur pour chaudière

VALVOLA A SFERA IN OTTONE STAMPATO E SABBIAIO.

- ASTA IN OTTONE MONTATA DALL'INTERNO CONTRO LE MANOMISSIONI E/O L'ESTRAZIONE E ANTI SCOPPIO
- TENUTA O-RINGS NBR
- SEDI IN PTFE
- LEVA IN ALLUMINIO
- FILETTATURE SECONDO UNI ISO 228/1
- LIMITI DI PRESSIONE 10 BAR (PN 10)
- LIMITI DI TEMPERATURA -20 +110 °C

Ball valve in forged and sandblasted brass.

- Brass rod mounted from the inside against tampering and/or extraction and anti-burst
- NBR O-ring seal
- PTFE seats
- Aluminum lever
- Threads according to UNI ISO 228/1
- Pressure limits 10 bar (PN 10)
- Temperature range -20 +110 °C

Robinet sphérique en laiton forgé et sablé.

- Tige en laiton montée de l'intérieur contre les manipulations et/ou extraction et anti-éclatement
- Joint torique NBR
- Sièges PTFE
- Poignée en aluminium
- Filetages selon UNI ISO 228/1
- Limites de pression 10 bar (PN 10)
- Limites de température -20 +110 °C

5845

RUBINETTO A SFERA PER SCARICO CALDAIA IN OTTONE CROMATO CON PORTAGOMMA E TAPPO. LEVA ALLUMINIO ROSSA.

Boiler drain-off ball valve with hose union and cap, chromium plated. Red aluminium lever.

Robinet purgeur pour chaudière avec raccord pour tuyau en caoutchouc et capuchon en laiton chromé. Poignée aluminium rouge.



Codice Code	Misura Size Dimensions		
5845 015	1/2"	40	160



5840

RUBINETTO A SFERA PER SCARICO CALDAIA IN OTTONE CON PORTAGOMMA E TAPPO. LEVA ALLUMINIO NERA.

Boiler drain-off ball valve with hose union and cap. Black aluminium lever.

Robinet purgeur pour chaudière avec raccord pour tuyau en caoutchouc et capuchon, poignée aluminium noire.



Codice Code	Misura Size Dimensions		
5840 015	1/2"	40	160
5840 020	3/4"	30	120

RUBINETTO ENOLOGICO

Wine tap

Robinet oenologique

2020 N



RUBINETTO ENOLOGICO IN OTTONE CROMATO.

Wine tap made in brass chromed.

Robinet oenologique en laiton chromé.

PN 16



Codice Code	Misura Size Dimensions		
2020N 010	3/8"	40	160
2020N 015	1/2"	40	160
2020N 020	3/4"	25	100

SERIE MINI Series Série

VALVOLA A SFERA IN OTTONE STAMPATO E SABBIAATO.

- ASTA IN OTTONE MONTATA DALL'INTERNO CONTRO LE MANOMISSIONI E/O L'ESTRAZIONE E ANTI SCOPPIO
- TENUTA O-RINGS NBR
- SEDI IN PTFE
- LEVA IN ALLUMINIO (PLASTICA PER 2325R)
- FILETTATURE SECONDO UNI ISO 228/1
- LIMITI DI PRESSIONE 16 BAR (PN 16)
- LIMITI DI TEMPERATURA -20 +110 °C

Ball valve in forged and sandblasted brass.

- Brass rod mounted from the inside against tampering and/or extraction and anti-burst
- NBR O-ring seal
- PTFE seats
- Aluminum lever (plastic for 2325R)
- Threads according to UNI ISO 228/1
- Pressure limits 16 bar (PN 16)
- Temperature range -20 +110 °C

Robinet sphérique en laiton forgé et sablé.

- Tige en laiton montée de l'intérieur contre les manipulations et/ou l'extraction et anti-éclatement
- Joint torique NBR
- Sièges PTFE
- Poignée en aluminium (plastique pour 2325R)
- Filetages selon UNI ISO 228/1
- Limites de pression 16 bar (PN 16)
- Limites de température -20 +110 °C

2300 R

MINI VALVOLA A SFERA F/F SERIE MIGNON, IN OTTONE CROMATO. LEVA ALLUMINIO ROSSA.

Mini brass ball valve F/F, MIGNON series, chromium plated. Red aluminium lever.

Mini vanne à boisseau sphérique, série MIGNON, en laiton chromé F/F, poignée aluminium rouge.



2310 R

MINI VALVOLA A SFERA M/F SERIE MIGNON, IN OTTONE CROMATO. LEVA ALLUMINIO ROSSA.

Mini brass ball valve M/F, MIGNON series, chromium plated. Red aluminium lever.

Mini vanne à boisseau sphérique, série MIGNON, en laiton chromé M/F, poignée aluminium rouge.



Disponibile con leva: Available with lever: Disponible avec levier:

2300B
Blu
Blue
Bleu



2300N
Nero
Black
Noir



ACS

Codice Code	Misura Size Dimensions	📦	📦
2300 008	1/4"	30	300
2300 010	3/8"	30	300
2300 015	1/2"	25	250

Disponibile con leva: Available with lever: Disponible avec levier:

2310B
Blu
Blue
Bleu



2310N
Nero
Black
Noir



ACS

Codice Code	Misura Size Dimensions	📦	📦
2310 008	1/4"	30	300
2310 010	3/8"	30	300
2310 015	1/2"	25	250
2310 020	3/4"	40	160

2335 R

MINI VALVOLA A SFERA PER COLLETTORI LEVA ROSSA CON ADATTATORE TUBO MULTISTRATO 16/12. FINITURA NICHELATA

Mini ball valve for manifold with adaptor for multilayer pipe 16/12 red lever. Nickel finishing.

Mini vanne à boisseau sphérique pour collecteur avec adaptateur pour tube multicouche 16/12 à levier rouge. Finition nickel.



Disponibile con leva: Available with lever: Disponible avec levier:

2335B
Blu
Blue
Bleu



Codice Code	Misura Size Dimensions	Per tubo For pipe Pour tube	📦	📦
2335R 015M1612	1/2" M x 1/2" M	16 x 2	20	200
2335B 015M1612	1/2" M x 1/2" M	16 x 2	20	200

2325 R

MIGNON MINI VALVOLA SFERA M/M 1/2" IN OTTONE LEVA PLASTICA ROSSA.

MIGNON ball valve "mini" M/M 1/2" red plastic lever.

Mini vanne à boisseau sphér. série MIGNON, M/M 1/2", poignée plastique rouge.



Codice Code	Misura Size Dimensions	📦	📦
2325R 015	1/2"	25	250

2340 N

MINI VALVOLA A SFERA F/F SERIE MIGNON, IN OTTONE CROMATO, FINITURA LUCIDA. LEVA ALLUMINIO NERA.

Mini brass ball valve F/F, MIGNON series, chromium plated, glossy finishing. Black aluminium lever.

Mini vanne à boisseau sphérique, série MIGNON, en laiton chromé F/F, aspect brillant. Poignée aluminium noir.



Codice Code	Misura Size Dimensions		
2340N 015	1/2" F/F	25	250

2350 N

MINI VALVOLA A SFERA M/F SERIE MIGNON, IN OTTONE CROMATO, FINITURA LUCIDA. LEVA ALLUMINIO NERA.

Mini brass ball valve M/F, MIGNON series, chromium plated, glossy finishing. Black aluminium lever.

Mini vanne à boisseau sphérique, série MIGNON, en laiton chromé M/F, aspect brillant. Poignée aluminium noir.



Codice Code	Misura Size Dimensions		
2350N 010	3/8" M/F	30	300
2350N 015	1/2" M/F	25	250

2340 C

MINI VALVOLA A SFERA F/F SERIE MIGNON, IN OTTONE CROMATO, FINITURA LUCIDA. LEVA ALLUMINIO CROMO.

Mini brass ball valve F/F, MIGNON series, chromium plated, glossy finishing. Chrome aluminium lever.

Mini vanne à boisseau sphérique, série MIGNON, en laiton chromé F/F, aspect brillant. Poignée aluminium chrome.



Codice Code	Misura Size Dimensions		
2340C 015	1/2" F/F	25	250

2350 C

MINI VALVOLA A SFERA M/F SERIE MIGNON, IN OTTONE CROMATO, FINITURA LUCIDA. LEVA ALLUMINIO CROMO.

Mini brass ball valve M/F, MIGNON series, chromium plated, glossy finishing. Chrome aluminium lever.

Mini vanne à boisseau sphérique, série MIGNON, en laiton chromé M/F, aspect brillant. Poignée aluminium chrome.



Codice Code	Misura Size Dimensions		
2350C 010	3/8" M/F	30	300
2350C 015	1/2" M/F	25	250

3450 R

RUBINETTO A SFERA A SQUADRA, ATTACCO M/F, CON CALOTTA LIBERA, PER SCALDABAGNO, SERIE GASTRONG, A NORME UNI C.I.G. LEVA ALLUMINIO ROSSA.

Angle ball bibcock M/F, swivel end, for water heaters, GASTRONG series; to UNI C.I.G. Red aluminium lever.

Vanne à boisseau sphérique équerre M/F avec écrou libre, pour chauffe eau, série GASTRONG, aux normes UNI C.I.G., poignée aluminium rouge.



Disponibile con leva: Available with lever: Disponible avec levier:

3450B
Blu
Blue
Bleu

Codice Code	Misura Size Dimensions		
3450R 015	1/2" x 1/2"	30	120
3450B 015	1/2" x 1/2"	30	120

3470 R

RUBINETTO A SFERA A SQUADRA, ATTACCO M/F 1/2", SERIE GASTRONG, A NORME UNI C.I.G. LEVA ALLUMINIO ROSSA.

Angle ball bibcock M/F, 1/2", GASTRONG series; to UNI C.I.G. Red aluminium lever.

Vanne à boisseau sphérique équerre M/F 1/2", série GASTRONG, aux normes UNI C.I.G., poignée aluminium rouge.



Disponibile con leva: Available with lever: Disponible avec levier:

3470B
Blu
Blue
Bleu

Codice Code	Misura Size Dimensions		
3470R 015	1/2" x 1/2"	30	120
3470B 015	1/2" x 1/2"	30	120

RUBINETTI DA GIARDINO

Garden bibcock

Robinets de puisage

RUBINETTO A SFERA CON PORTAGOMMA IN OTTONE STAMPATO, SABBIAATO E NICHELATO.

- ASTA IN OTTONE MONTATA DALL'INTERNO CONTRO LE MANOMISSIONI E/O L'ESTRAZIONE E ANTISCOPPIO
- SFERA IN OTTONE DIAMANTATA E CROMATA
- SEDI IN PTFE
- LEVA IN ALLUMINIO O IN ACCIAIO E CON RIVESTIMENTO IN PVC
- FILETTATURE SECONDO ISO 228/1
- LIMITI DI PRESSIONE 25 BAR (PN 25)
- LIMITI DI TEMPERATURA -20 +120 °C

Hose union ball bibcock made of forged brass, sand-blasted and nickel plated.

- Brass stem assembled from inside to avoid tampering, extraction or explosion
- Brass solid ball with cleaned and chromium plated surface
- PTFE seats
- Lever made of painted aluminium or made of steel with PVC coating
- Threads according to ISO 228/1
- Pressure limits 25 bar (PN 25)
- Temperature range -20 +120 °C

Robinet à boisseau sphérique en laiton matricé, sablé et nickelé.

- Tige en laiton montée de l'intérieur contre les altérations et/ou l'extraction et anti éclat
- Sphère diamantée et chromée
- Sièges en PTFE
- Poignée en aluminium ou en acier avec revêtement en PVC
- Filetages selon ISO 228/1
- Limites de pression 25 bar (PN 25)
- Limites de température -20 +120 °C

2090 B

RUBINETTO A SFERA CON PORTAGOMMA, TIPO PESANTE, IN OTTONE NICHELATO. LEVA ALLUMINIO BLU.

Hose union ball bibcock heavy type, made of brass, nickel plated. Blue aluminium lever.

Robinet à boisseau sphérique avec raccord au nez, type lourd, en laiton nickelé, poignée aluminium bleue.



Codice Code	Misura Size Dimensions	☐	📦
2090B 015 ☒	1/2" x 3/4"	15	60
2090B 020 ☒	3/4" x 1"	10	40

2050 N

RUBINETTO A SFERA CON PORTAGOMMA, IN OTTONE NICHELATO. LEVA ALLUMINIO NERA.

Hose union ball bibcock, made of brass, nickel plated. Black aluminium lever.

Robinet à boisseau sphérique avec raccord au nez, en laiton nickelé, poignée aluminium noir.



Codice Code	Misura Size Dimensions	☐	📦
2050N 015 ☒	1/2"	20	80

2060 LP

RUBINETTO A SFERA SERIE STAR CON PORTAGOMMA, TIPO NORMALE, IN OTTONE NICHELATO. LEVA ALLUMINIO ROSSA.

Hose union ball bibcock, STAR series, standard type, made of brass, nickel plated. Red aluminium lever.

Robinet à boisseau sphérique, série STAR, avec raccord au nez, standard, en laiton nickelé, poignée aluminium rouge.

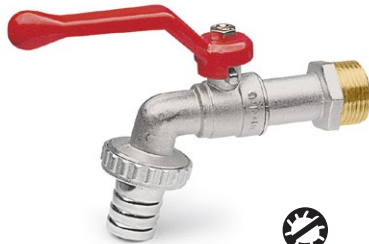

Codice Code	Misura Size Dimensions	☐	📦
2060LP 010 ☒	3/8" x 3/4"	20	80
2060LP 015 ☒	1/2" x 3/4"	20	80
2060LP 020 ☒	3/4" x 1"	12	48
2060LP 025 ☒	1" x 1 1/4"	8	32

2060 ST

RUBINETTO A SFERA SERIE STAR CON PORTAGOMMA, TIPO NORMALE, IN OTTONE NICHELATO. LEVA PIATTA ROSSA IN ACCIAIO.

Hose union ball bibcock, STAR series, standard type, made of brass, nickel plated. Red flat steel lever.

Robinet à boisseau sphérique, série STAR, avec raccord au nez, standard, en laiton nickelé, poignée acier rouge.



Codice Code	Misura Size Dimensions	☐	📦
2060ST 010 ☒	3/8" x 3/4"	20	80
2060ST 015 ☒	1/2" x 3/4"	20	80
2060ST 020 ☒	3/4" x 1"	12	48
2060ST 025 ☒	1" x 1 1/4"	8	32

2060 T

RUBINETTO A SFERA SERIE STAR CON PORTAGOMMA, TIPO NORMALE, IN OTTONE NICHELATO. LEVA ALLUMINIO ROSSA.

Hose union ball bibcock, STAR series, standard type, made of brass, nickel plated. Red aluminum butterfly handle.

Robinet à boisseau sphérique, série STAR, avec raccord au nez, standard, en laiton nickelé, poignée aluminium rouge.

**ACS**

Codice Code	Misura Size Dimensions		
2060T 010	3/8" x 3/4"	20	80
2060T 015	1/2" x 3/4"	20	80
2060T 020	3/4" x 1"	12	48
2060T 025	1" x 1 1/4"	8	32

2080

RUBINETTO A SFERA SERIE STAR CON PORTAGOMMA, TIPO NORMALE, IN OTTONE NICHELATO. LEVA IN ACCIAIO IMBUTITA ROSSA SIGILLABILE.

Hose union ball bibcock, STAR series, standard type, made of brass, nickel plated. With locking red drawn steel lever.

Robinet à boisseau sphérique, série STAR, avec raccord au nez, standard, en laiton nickelé, poignée acier rouge plombable.

**ACS**

Codice Code	Misura Size Dimensions		
2080 015	1/2" x 3/4"	20	80

2040 ST

RUBINETTO A SFERA DA GIARDINO DOPPIO CON PORTAGOMMA E MINIVALVOLA. LEVA PIATTA ROSSA IN ACCIAIO.

Hose union ball bibcock with mini ball valve made in brass nickel plated. Red flat steel lever.

Robinet à boisseau sphérique, de puisage double avec raccord au nez, et minivanne. Poignée acier rouge.

PN 16



COD2070 015
Per rubinetto for bibcock pour robinet 2040ST

Codice Code	Misura Size Dimensions		
2040ST 015	1/2" x 3/4" x 3/4"	12	48
COD2070 015	3/4"	-	-

2040 STV

RUBINETTO A SFERA DA GIARDINO DOPPIO CON PORTAGOMMA E MINIVALVOLA. LEVA PIATTA VERDE IN ACCIAIO.

Hose union ball bibcock with mini ball valve made in brass nickel plated. Green flat steel lever.

Robinet à boisseau sphérique, de puisage double avec raccord au nez, et minivanne. Poignée acier verte.

PN 16



COD2070 015
Per rubinetto for bibcock pour robinet 2040STV

Codice Code	Misura Size Dimensions		
2040STV 015	1/2" x 3/4" x 3/4"	12	48
COD2070 015	3/4"	-	-

2063 ST

RUBINETTO A SFERA CON PORTAGOMMA, TIPO COMPATTO, IN OTTONE NICHELATO. LEVA PIATTA ROSSA IN ACCIAIO.

Hose union ball bibcock, compaq type, made of brass, nickel plated. Red flat steel lever.

Robinet à boisseau sphérique, avec raccord au nez, compact, en laiton nickelé. Poignée acier rouge.

**ACS**

Codice Code	Misura Size Dimensions		
2063ST 015	1/2" x 3/4"	20	80
2063ST 020	3/4" x 1"	12	48

2063 LP

RUBINETTO A SFERA CON PORTAGOMMA, TIPO COMPATTO, IN OTTONE NICHELATO. LEVA ALLUMINIO ROSSA.

Hose union ball bibcock, compaq type, made of brass, nickel plated. Red aluminium lever.

Robinet à boisseau sphérique, avec raccord au nez, compact, en laiton nickelé. Poignée aluminium rouge.

**ACS**

Codice Code	Misura Size Dimensions		
2063LP 015	1/2" x 3/4"	20	80
2063LP 020	3/4" x 1"	12	48

7800 OL

RUBINETTO A COLLO IN OTTONE LUCIDO.

Neck bibcock T lever, shiny brass.

Robinet en laiton brillant.

PN 20



Codice Code	Misura Size Dimensions		
7800 OL 015	1/2"	20	80

7950 OL

RUBINETTO A COLLO IN OTTONE LUCIDO CON PORTAGOMMA.

Neck bibcock T lever, with hose union, shiny brass.

Robinet avec raccord au nez en laiton brillant.

PN 20



Codice Code	Misura Size Dimensions		
7950 OL 01520	1/2" x 3/4"	15	60

070 CL

RUBINETTO DA GIARDINO TIPO TEDESCO, CROMATO LUCIDO.

German tap, shiny chromium plated.

Robinet de paysage avec raccord au nez, version allemande, chromé brillant.

PN 20



Codice Code	Misura Size Dimensions		
070CL 01520	1/2" x 3/4"	15	60

070 CS

RUBINETTO DA GIARDINO TIPO TEDESCO, SABBIAIO E CROMATO.

German tap, sand blasted chromium plated.

Robinet de jardin avec raccord au nez, version allemande, sablé, chromé.

PN 20



Codice Code	Misura Size Dimensions		
070CS 01520	1/2" x 3/4"	15	60

2030 T

RUBINETTO A SFERA ATTACCO IDRANTE IN OTTONE. LEVA ALLUMINIO ROSSA.

Hydrant ball valve in brass. Red aluminium butterfly handle.

Robinet à boisseau sphérique avec fixation pour bouche d'eau en laiton. Poignée aluminium rouge.



Codice Code	Misura Size Dimensions		
2030T 015	1/2" x 3/4"	25	100

COD2070

RACCORDO RAPIDO PER RUBINETTI IN OTTONE.

Quick coupling for bibcocks in brass.

Raccord rapide pour robinets en laiton.



Codice Code	Misura Size Dimensions
COD2070 015	3/4" per rubinetto for bibcock pour robinet 1/2"

COD2060

GIRELLO E BOCCHETTONE PER RUBINETTI, IN OTTONE.

Nut and tail for hose union bib cock, made of brass.

Raccord prolongation en laiton pour robinets de paysage.



Codice Code	Misura Size Dimensions
COD2060 015	3/4" per rubinetto for bibcock pour robinet 1/2"
COD2060 020	1" per rubinetto for bibcock pour robinet 3/4"
COD2060 025	1" 1/4 per rubinetto for bibcock pour robinet 1"

VALVOLE DA INCASSO

Built-in ball valve

Vannes à encastrer

2570

VALVOLA A SFERA DA INCASSO, SERIE SPATIAL, PASSAGGIO TOTALE, CON SISTEMA ASTA E SFERA ESTRAIBILI. CAPPUCCIO E ROSONE CROMATI.

Full way built-in ball valve, SPATIAL series, with the possibility to take out the stem and the ball. With chromium plated lockshield and top.

Vanne à boisseau sphérique à encastrer, série SPATIAL, passage intégral, tige et sphère extractible. Capuchon et rosace chromés.



1

Codice Code	Misura Size Dimensions		
2570 015	1/2"	8	32

2580

VALVOLA A SFERA DA INCASSO, SERIE SPATIAL, PASSAGGIO TOTALE, CON SISTEMA ASTA E SFERA ESTRAIBILI. DEVIATORE E ROSONE CROMATI.

Full way built-in ball valve, SPATIAL series, with the possibility to take out the stem and the ball. With chromium plated lockshield and lever.

Vanne à boisseau sphérique à encastrer, série SPATIAL, passage intégral, tige et sphère extractible. Inverseur et rosace chromés.



2590

VALVOLA A SFERA DA INCASSO, SERIE SPATIAL, PASSAGGIO TOTALE, CON SISTEMA ASTA E SFERA ESTRAIBILI. MANIGLIA E ROSONE CROMATI.

Full way built-in ball valve, SPATIAL series, with the possibility to take out the stem and the ball. With chromium plated lockshield and handle.

Vanne à boisseau sphérique à encastrer, série SPATIAL, passage intégral, tige et sphère extractible. Poignée et rosace chromés.



Codice Code	Misura Size Dimensions		
2580 015	1/2"	8	32

Codice Code	Misura Size Dimensions		
2590 015	1/2"	8	32

2650

VALVOLA A SFERA DA INCASSO, SERIE QUADRO, PASSAGGIO TOTALE, CON SISTEMA ASTA E SFERA ESTRAIBILI. DEVIATORE E ROSONE CROMATI.

Full way built-in ball valve, SQUARE series, with the possibility to take out the stem and the ball. With chromium plated lockshield and lever.

Vanne à boisseau sphérique à encastrer, série CARRE, passage intégral, tige et sphère extractible. Inverseur et rosace chromés.



2600

VALVOLA A SFERA DA INCASSO, SERIE TONDO, PASSAGGIO TOTALE, CON SISTEMA ASTA E SFERA ESTRAIBILI. DEVIATORE E ROSONE CROMATI.

Full way built-in ball valve, ROUND series, with the possibility to take out the stem and the ball. With chromium plated lockshield and lever.

Vanne à boisseau sphérique à encastrer, série ROND, passage intégral, tige et sphère extractible. Inverseur et rosace chromés.



Codice Code	Misura Size Dimensions		
2650 015	1/2"	8	32

Codice Code	Misura Size Dimensions		
2600 015	1/2"	8	32

PO2540

SET PROLUNGA PER VALVOLE INCASSO.

Extension set for built-in ball valves.

Set rallonge pour vanne à encastrer.

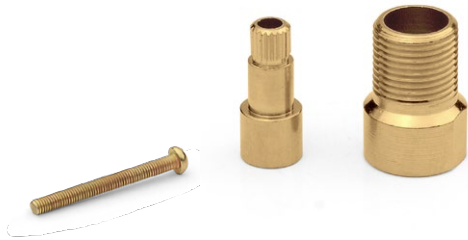

Codice Code	Misura Size Dimensions	8	32
PO2540			

2575

VALVOLA A SFERA DA INCASSO, SERIE METEOR. CAPPuccio E ROSONE CROMATI.

Built-in ball valve, METEOR series. With chromium plated lockshield and top.

Vanne à boisseau sphérique à encastrer, série METEOR. Capuchon et rosace chromés.



Codice Code	Misura Size Dimensions	8	32
2575 015	1/2"		

2585

VALVOLA A SFERA DA INCASSO, SERIE METEOR. DEVIATORE E ROSONE CROMATI.

Built-in ball valve, METEOR series. With chromium plated lockshield and lever.

Vanne à boisseau sphérique à encastrer, série METEOR. Inverseur et rosace chromés.



Codice Code	Misura Size Dimensions	8	32
2585 015	1/2"		

2595

VALVOLA A SFERA DA INCASSO, SERIE METEOR. MANIGLIA E ROSONE CROMATI.

Built-in ball valve, METEOR series. With chromium plated lockshield and handle.

Vanne à boisseau sphérique à encastrer, série METEOR. Poignée et rosace chromés.



Codice Code	Misura Size Dimensions	8	32
2595 015	1/2"		

VALVOLE A SFERA PER GAS

Gas ball valves

Vannes à boisseau sphérique pour Gas

RUBINETTO A SFERA PER GAS DA INCASSO

Built-in gas ball valve Robinet à boisseau sphérique pour GAS à encastrer

SERIE GAS

Series Série

SERIE GASTRONG

Series Série

VALVOLE A SFERA PER GAS

Gas ball valves

Vannes à boisseau sphérique pour **Gas**

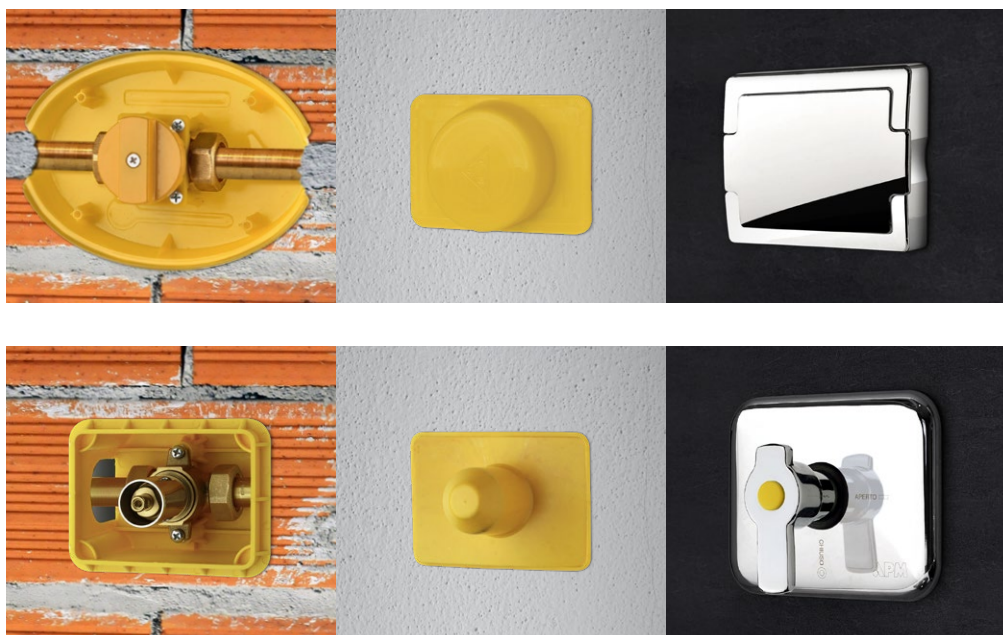

APPROVAZIONI INTERNAZIONALI

Le valvole a sfera da incasso APM soddisfano i requisiti delle norme EN 331 e UNI-CIG 7129.

INTERNATIONAL APPROVALS

The built-in ball valves APM meet the requirements of EN 331 and UNI-CIG 7129.

HOMOLOGATIONS INTERNATIONALES

Les vannes à boisseau sphérique à encastrer APM répondent aux exigences des normes EN 331 et UNI-CIG 7129.

PO3500

SET PROLUNGA PER VALVOLA SERIE 3500.

Extension set for valves 3500 series.

Set rallonge pour vanne série 3500.



DIAGRAMMA DI PRESSIONE/TEMPERATURA

Pressure/temperature diagram

Diagramme de pression/température

Prova eseguita con acqua
Test executed with water
Test réalisé avec eau

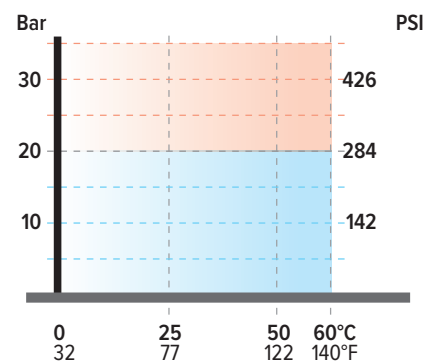

Codice Code	Misura Size	Dimensions		
PO3500			1	10

3500

RUBINETTO A SFERA PER GAS DA INCASSO CON FLANGETTA DI FISSAGGIO E PERNO DI SUPPORTO, ISPEZIONABILE COME DA NORMA UNI CIG 7129, COMPLETO DI LEVA E PIASTRA CROMATI, ATTACCHI A SALDARE PER TUBO RAME CASSETTA DA INCASSO.

Built-in monoblock ball valve for gas with checking point to uni norm UNI CIG 7129 complete of chromed plate and handle, plastic built-in box and fittings for copper tube.

Vanne à boisseau sphérique pour GAS à encastrer avec bride de fixation et broche de support, inspectionable aux normes UNI CIG 7129, complet de poignée et plaque chromées, sorties à souder pour tubes cuivre et boîtier à encastrer.

Codice Code	Misura Size Dimensions	1	10
3500	Senza raccordi/Without fittings/Sans raccords	1	10
3500.14	Raccordi/Fittings/Raccords Ø14	1	10
3500.16	Raccordi/Fittings/Raccords Ø16	1	10

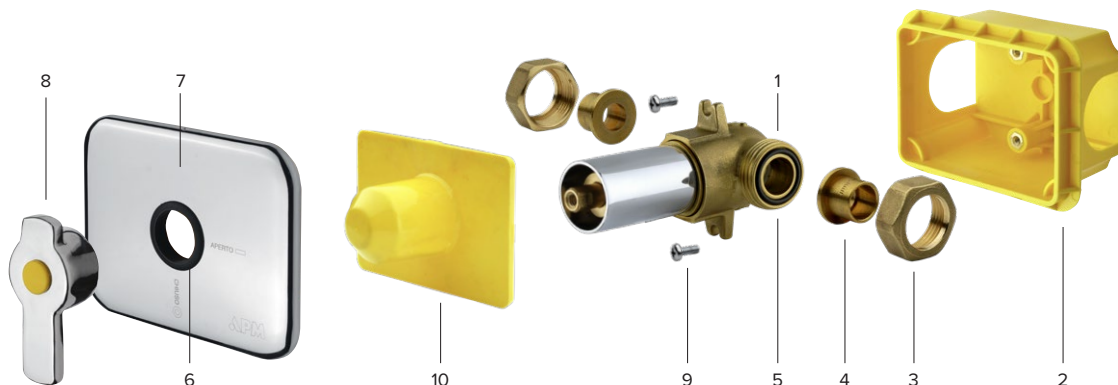
**COMPONENTI**

1	Valvola a sfera Ball valve Vanne à boisseau sphérique	3	Dadi di fissaggio Brass nut Ecroi de fixation	5	O-rings O-rings O-rings	7	Piastra di copertura Chromed plate Plaque de couverture	9	Viti di fissaggio Fixing kit Vis de fixation
2	Cassetta di ispezione Built-in plastic box Boîtier d'inspection	4	Codoli per saldatura Weld fittings Queue pour soudure	6	Guarnizione Rubber gasket Joints	8	Leva Chromed handle Poignée	10	Coperchio di protezione Protection cover Couvercle de protection

3505

PRESA A MURO INCASSO GAS CON RACCORDO CURVO.

Built-in gas wall outlet with curved connection.

Sortie murale à gas avec raccord courbé.

Codice Code	Misura Size Dimensions	1	10
3505	M 3/4" x F 1/2"	1	10

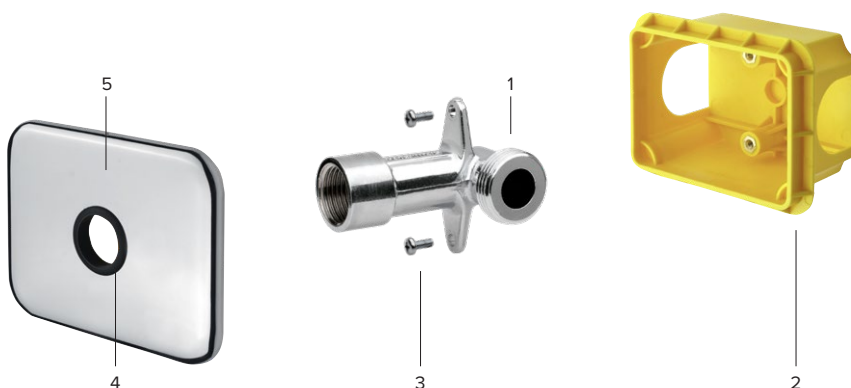
**COMPONENTI**



1	Raccordo Fitting Raccord	3	Viti di fissaggio Fixing kit Vis de fixation	5	Piastra di copertura Chromed plate Plaque de couverture
2	Cassetta di ispezione Built-in plastic box Boîtier d'inspection	4	Guarnizione Rubber gasket Joints		

3530

RUBINETTO A SFERA PER GAS DA INCASSO CON FLANGETTA DI FISSAGGIO E PERNO DI SUPPORTO, ISPEZIONABILE COME DA NORMA UNI CIG 7129, COMPLETO DI LEVA, ATTACCHI A SALDARE PER TUBO RAME O FERRO E CASSETTA DA INCASSO. MODELLO OVALE.

Built-in monoblock ball valve for gas with checking point to uni norm UNI CIG 7129 complete of handle, plastic built-in box and fittings for copper tube or iron connection.

Vanne à boisseau sphérique pour GAS à encastrer avec bride de fixation et broche de support, inspectionable aux normes UNI CIG 7129, complet de poignée, sorties à souder pour tubes cuivre ou de fer et boîtier à encastrer. Modèle ovale.

Codice Code	Misura Size Dimensions		
3530	Senza raccordi/Without fittings/Sans raccords	1	10
3530.14	Raccordi/Fittings/Raccords Ø14	1	10
3530.16	Raccordi/Fittings/Raccords Ø16	1	10
G3530 B	Sportellino bianco White door Couvre blanc	1	-
G3530 C	Sportellino cromo Chrome door Couvre chromé	1	-

* G 3530 sportello non incluso-cover not included-couvre boîtier non inclus

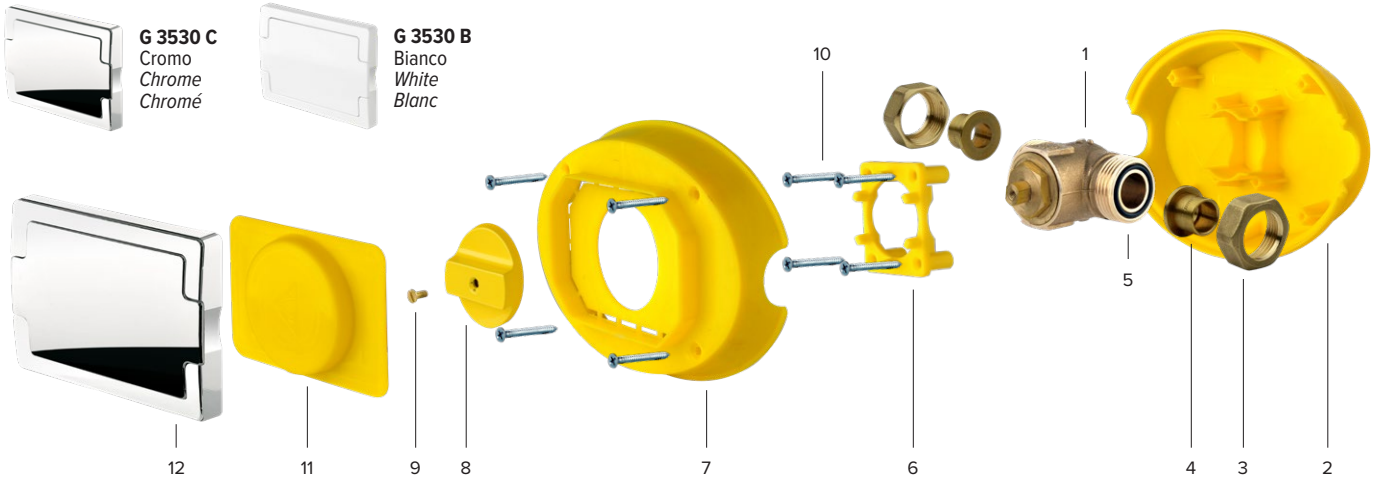

COMPONENTI



- | | | | | | |
|--|---|---|---|---|---|
| 1 Valvola a sfera attacchi a saldare
Ball valve, Raccords for copper tube
Vanne à boisseau sphérique
connexion à souder | 2 Cassetta di ispezione
Built-in plastic box
Boîtier d'inspection | 4 Codoli per saldatura
Weld fittings
Queue pour soudure | 6 Partic. per fissaggio
Component mounting
Accessoire de fixation | 8 Leva
Handle
Poignée | 11 Coperchio di protezione
Protective cover
Couvercle de protection |
| | 3 Dadi di fissaggio
Brass nut
Ecrou de fixation | 5 O-rings
O-rings
O-rings | 7 Coperchio cassetta
Box cover
Couvercle boîte | 9-10 Viti di fissaggio
Fixing kit
Vis de fixation | 12 Sportello
Cover
Couvre boîtier |

3630

RUBINETTO A SFERA PER GAS DA INCASSO CON FLANGETTA DI FISSAGGIO E PERNO DI SUPPORTO, SPEZIONABILE COME DA NORMA UNI CIG 7129, COMPLETO DI LEVA E PIASTRA CROMATI, ATTACCO F/F 1/2" E CASSETTA DA INCASSO. MODELLO OVALE.

Built-in monoblock ball valve for gas with checking point to uni norm UNI CIG 7129 complete of chromed plate and handle, plastic built-in box 1/2" female connections.

Vanne à boisseau sphérique pour GAS à encastrer avec bride de fixation et broche de support, inspectionable aux normes UNI CIG 7129, complet de poignée et plaque chromées, sorties F/F 1/2" et boîtier à encastrer. Modèle ovale.

Codice Code	Misura Size Dimensions		
3630	1/2" x 1/2" attacco ferro iron connect. connex. fer	1	10
G3530 B	Sportellino bianco White door Couvre blanc	1	-
G3530 C	Sportellino cromo Chrome door Couvre chromé	1	-

* G 3530 sportello non incluso-cover not included-couvre boîtier non inclus

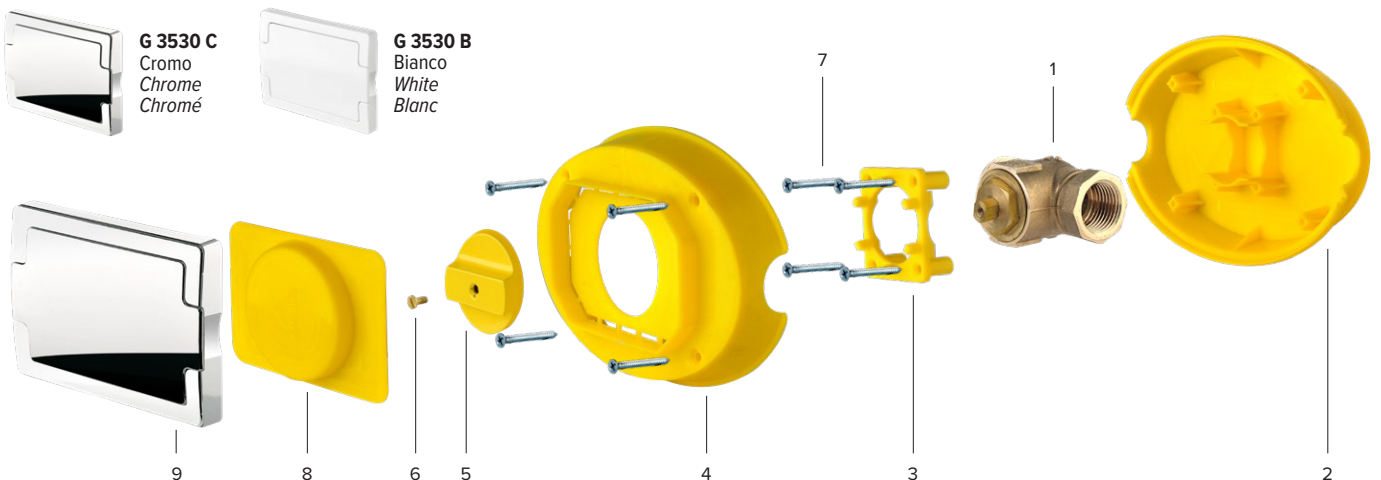

COMPONENTI

- | | | | | |
|--|---|--|--|--|
| 1 Valvola a sfera attacco ferro
Ball valve, iron connection
Vanne à boisseau sphérique
connexion tubes fe | 2 Cassetta di ispezione
Built-in plastic box
Boîtier d'inspection | 4 Coperchio cassetta
Box cover
Couvercle boîte | 6-7 Viti di fissaggio
Fixing kit
Vis de fixation | 9 Sportello
Cover
Couvre boîtier |
| | 3 Particolare per fissaggio
Component mounting
Accessoire de fixation | 5 Leva
Handle
Poignée | 8 Coperchio di protezione
Protective cover
Couvercle de protection | |

3510

RUBINETTO A SFERA PER GAS DA INCASSO CON FLANGETTA DI FISSAGGIO E PERNO DI SUPPORTO, ISPEZIONABILE COME DA NORMA UNI CIG 7129, COMPLETO DI LEVA, ATTACCHI A SALDARE PER TUBO RAME O FERRO E CASSETTA DA INCASSO. MODELLO OVALE.

Built-in monoblock ball valve for gas with checking point to uni norm UNI CIG 7129 complete of handle, plastic built-in box and fittings for copper tube or iron connection.

Vanne à boisseau sphérique pour GAS à encastrer avec bride de fixation et broche de support, inspectionable aux normes UNI CIG 7129, complet de poignée, sorties à souder pour tubes cuivre ou de fer et boîtier à encastrer. Modèle ovale.

Codice Code	Misura Size Dimensions	1	10
3510	Senza raccordi/Without fittings/Sans raccords	1	10
3510.14	Raccordi/Fittings/Raccords Ø14	1	10
3510.16	Raccordi/Fittings/Raccords Ø16	1	10

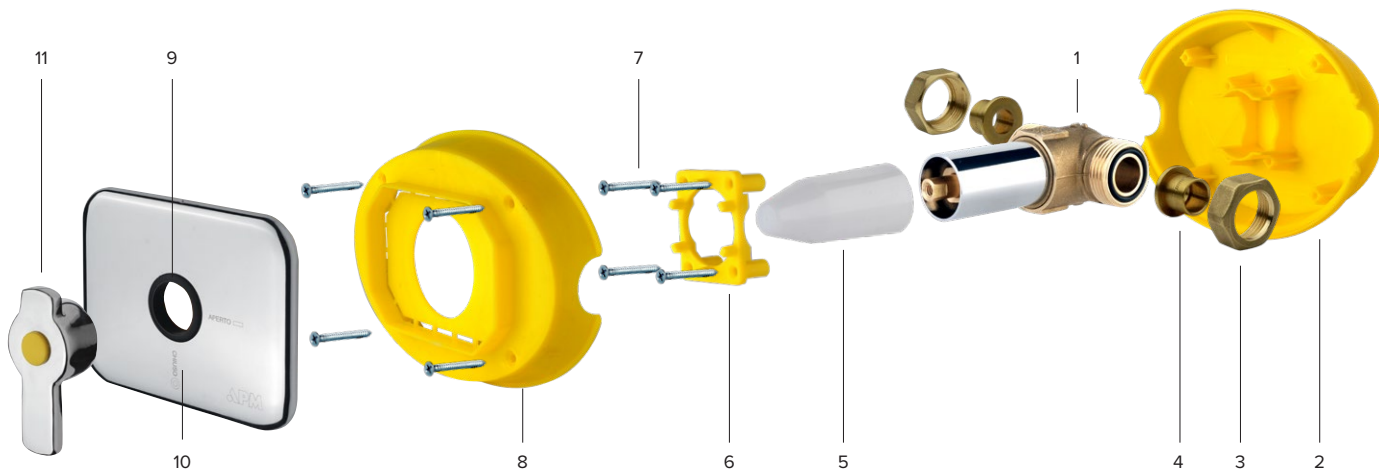

COMPONENTI

- | | | | | | |
|--|---|--|---|--|--|
| 1 Valvola a sfera attacchi a saldare
Ball valve, Raccords for copper tube
Vanne à boisseau sphérique
connexion à souder | 2 Cassetta di ispezione
Built-in plastic box
Boîtier d'inspection | 4 Codoli per saldatura
Weld fittings
Queue pour soudure | 6 Partic. per fissaggio
Component mounting
Accessoire de fixation | 8 Coperchio cassetta
Box cover
Couvercle boîte | 10 Piastra di copertura
Chromed plate
Plaque de couverture |
| | 3 Dadi di fissaggio
Brass nut
Ecrou de fixation | 5 Coperchio di protezione
Protective cover
Couvercle de protection | 7 Viti di fissaggio
Fixing kit
Vis de fixation | 9 Guarnizione
Rubber gasket
Joints | 11 Leva
Chromed handle
Poignée |

3600

RUBINETTO A SFERA PER GAS DA INCASSO CON FLANGETTA DI FISSAGGIO E PERNO DI SUPPORTO, SPEZIONABILE COME DA NORMA UNI CIG 7129, COMPLETO DI LEVA E PIASTRA CROMATI, ATTACCO F/F 1/2" E CASSETTA DA INCASSO. MODELLO OVALE.

Built-in monoblock ball valve for gas with checking point to uni norm UNI CIG 7129 complete of chromed plate and handle, plastic built-in box 1/2" female connections.

Vanne à boisseau sphérique pour GAS à encastrer avec bride de fixation et broche de support, inspectionable aux normes UNI CIG 7129, complet de poignée et plaque chromées, sorties F/F 1/2" et boîtier à encastrer. Modèle ovale.

Codice Code	Misura Size Dimensions	1	10
3600	1/2" x 1/2" attacco ferro iron connect. connex. fer	1	10

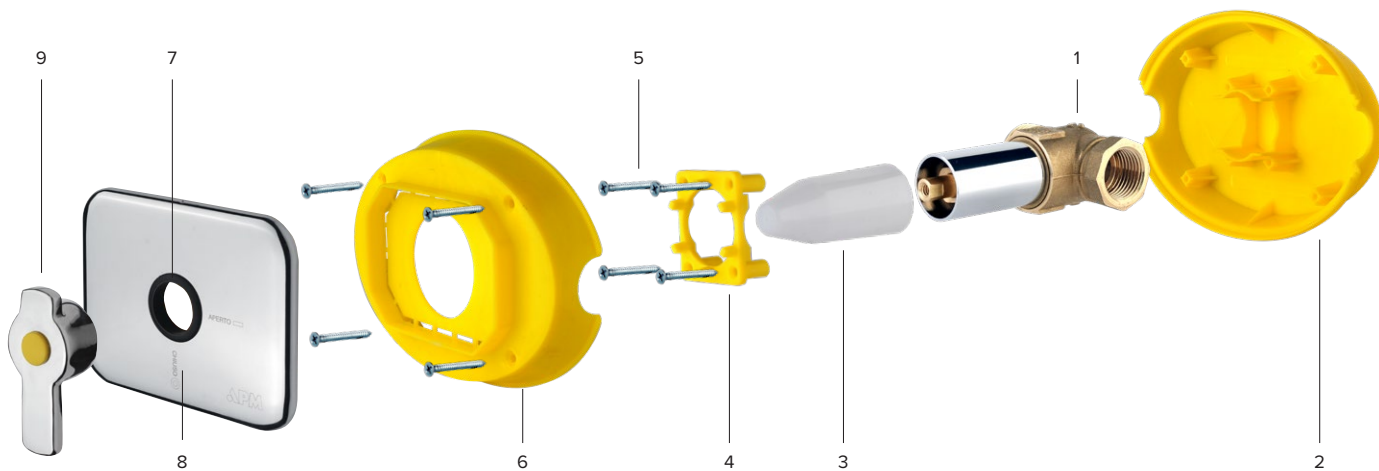

COMPONENTI

- | | | | | |
|--|--|---|--|---|
| 1 Valvola a sfera attacco ferro
Ball valve, iron connection
Vanne à boisseau sphérique
connexion tubes fe | 2 Cassetta di ispezione
Built-in plastic box
Boîtier d'inspection | 4 Particolare per fissaggio
Component mounting
Accessoire de fixation | 6 Coperchio cassetta
Box cover
Couvercle boîte | 8 Piastra di copertura
Chromed plate
Plaque de couverture |
| | 3 Coperchio di protezione
Protective cover
Couvercle de protection | 5 Viti di fissaggio
Fixing kit
Vis de fixation | 7 Guarnizione
Rubber gasket
Joints | 9 Leva
Chromed handle
Poignée |

SERIE GAS Series Série

VALVOLA A SFERA, SERIE GAS, IN OTTONE STAMPATO, SABBIAIO E NICHELATO A NORMA UNI CIG.

- ASTA IN OTTONE CON DOPPIO ORING MONTATA DALL'INTERNO CONTRO LE MANOMISSIONI E/O L'ESTRAZIONE E ANTISCOPPIO
- SFERA IN OTTONE DIAMANTATA E CROMATA
- SEDI IN PTFE CON DIM. SECONDO EN 331 (GARANTISCONO UN ANGOLO DI TENUTA DI 8°)
- LEVA IN ACCIAIO ZINCATO CON RIVESTIMENTO IN PVC GIALLO [SERIE STG], FARFALLA GIALLA IN ALLUMINIO [SERIE TG]
- FILETTATURE SECONDO ISO 71

Full way ball valve, GAS series, made of forged brass, sand-blasted and nickel plated to UNICIG.

- Brass stem with double O-ring assembled from inside to avoid tampering, extraction or explosion
- Brass solid ball with cleaned and chromium plated surface
- PTFE seats in accordance with EN 331 (designed with a 8° tightness angle)
- Lever made of steel with yellow PVC coating [STG series], yellow aluminium butterfly handle [TG series]
- Threads according to ISO 71

Vanne à boisseau sphérique, série GAS, en laiton matricé, sablé et nickelé, passage intégral à norme UNI CIG.

- Tige en laiton avec O-ring montée de l'intérieur contre les altérations et/ou l'extraction et anti éclat
- Sphère diamantée et chromée
- Sièges en PTFE avec dimensions selon EN 331 (garantissent un équerre d'étanchéité de 8°)
- Poignée: en acier avec revêtement en PVC jaune [série STG], papillon jaune en aluminium [série TG]
- Filetages selon ISO 71

3040 STG

VALVOLA A SFERA SERIE GAS, IN OTTONE NICHELATO, FILETTATURE F/F. A NORME UNI C.I.G. LEVA PIATTA GIALLA IN ACCIAIO.

Ball valve F/F, GAS series, made of brass, nickel plated; to UNI CIG. Yellow flat steel lever.

Vanne à boisseau sphérique, série GAS, en laiton nickelé, F/F, aux normes UNI C.I.G., poignée acier jaune.

PN 40



EN 331

Codice Code	Misura Size Dimensions	☐	📦
3040STG 015	1/2"	25	100
3040STG 020	3/4"	15	60
3040STG 025	1"	12	48

3040 TG

VALVOLA A SFERA SERIE GAS, IN OTTONE NICHELATO, FILETTATURE F/F. A NORME UNI C.I.G. FARFALLA ALLUMINIO GIALLA.

Ball valve F/F, GAS series, made of brass, nickel plated; to UNI CIG. Yellow aluminium butterfly handle.

Vanne à boisseau sphérique, série GAS, en laiton nickelé, F/F, aux normes UNI C.I.G., poignée papillon aluminium jaune.

PN 40



EN 331

Codice Code	Misura Size Dimensions	☐	📦
3040TG 015	1/2"	30	120
3040TG 020	3/4"	20	80
3040TG 025	1"	12	48

3042 TG - 3052 TG

VALVOLA A SFERA SERIE GAS, IN OTTONE NICHELATO, FILETTATURE F/F. A NORME UNI C.I.G., CON ATTACCO A PRESSIONE. FARFALLA ALLUMINIO GIALLA.

Full way ball valve F/F, GAS series, made of brass, nickel plated; to UNI CIG, with pressure mounting. Yellow aluminium butterfly handle.

Vanne à boisseau sphérique, série GAS, en laiton nickelé, passage intégral F/F, aux normes UNI C.I.G., sortie à pression. Poignée papillon aluminium jaune.



3042TG



3052TG

Codice Code	Misura Size Dimensions	☐	📦
3042TG 020	3/4"	25	100
3042TG 025	1"	12	48
3052TG 020	3/4"	25	100

3070 STG

VALVOLA A SFERA SERIE GAS, IN OTTONE NICHELATO, FILETTATURE M/F. A NORME UNI C.I.G. LEVA PIATTA GIALLA IN ACCIAIO.

Ball valve M/F, GAS series, made of brass, nickel plated; to UNI CIG. Yellow flat steel lever.

Vanne à boisseau sphérique, série GAS, en laiton nickelé, M/F, aux normes UNI C.I.G., poignée acier jaune.

PN 40



EN 331

Codice Code	Misura Size Dimensions	☐	📦
3070STG 015	1/2"	25	100
3070STG 020	3/4"	15	60
3070STG 025	1"	12	48

3070 TG

VALVOLA A SFERA SERIE GAS, IN OTTONE NICHELATO, FILETTATURE M/F. A NORME UNI C.I.G. FARFALLA ALLUMINIO GIALLA.

Ball valve M/F, GAS series, made of brass, nickel plated; to UNI CIG. Yellow aluminium butterfly handle.

Vanne à boisseau sphérique, série GAS, en laiton nickelé, M/F, aux normes UNI C.I.G., poignée papillon aluminium jaune.

PN 40



EN 331

Codice Code	Misura Size Dimensions	☐	📦
3070TG 015	1/2"	30	120
3070TG 020	3/4"	20	80
3070TG 025	1"	12	48

SERIE GASTRONG Series Série

RUBINETTO A SFERA PER GAS PER USO DOMESTICO SECONDO UNI CIG 7141 IN OTTONE STAMPATO, SABBIA TO E CROMATO.

- ASTA IN OTTONE CON DOPPIO ORING MONTATA DALL'INTERNO CONTRO LE MANOMISSIONI E/O L'ESTRAZIONE E ANTISCOPPIO
- SFERA IN OTTONE DIAMANTATA E CROMATA
- SEDI IN PTFE
- LEVA IN: ALLUMINIO CON RIVESTIMENTO IN RESINA EPOSSIDICA GIALLA

Gas hose union ball valve made of forged brass, sand-blasted and chromium plated, to UNI CIG 7141.

- Brass stem with double O-ring assembled from inside to avoid tampering, extraction or explosion
- Brass solid ball with cleaned and chromium plated surface
- PTFE seats
- Lever made of aluminium coated with yellow epoxy resin

Vanne à boisseau sphérique pour utilisation domestique selon UNI CIG 7141, en laiton matricé, sablé et chromée.

- Tige en laiton avec double O-ring montée de l'intérieur contre les altérations et/ou l'extraction et anti éclat
- Sphère en laiton diamantée et chromée
- Sièges en PTFE
- Poignée: en aluminium avec revêtement en résine époxydique jaune

3480

RUBINETTO A SFERA A SQUADRA, ATTACCO M/M 1/2", SERIE GASTRONG, A NORME UNI C.I.G. LEVA ALLUMINIO GIALLA.

Angle ball bibcock M/M, 1/2", GASTRONG series; to UNI CIG. Yellow aluminium lever.

Vanne à boisseau sphérique équerre M/M 1/2", série GASTRONG, aux normes UNI C.I.G., poignée aluminium jaune.



Codice Code	Misura Size Dimensions		
3480 015	1/2" x 1/2"	30	120



3450

RUBINETTO A SFERA A SQUADRA, ATTACCO M/F, CON CALOTTA LIBERA, PER SCALDABAGNO, SERIE GASTRONG, A NORME UNI C.I.G. LEVA ALLUMINIO GIALLA.

Angle ball bibcock M/F, swivel end, for water heaters, GASTRONG series; to UNI CIG. Yellow aluminium lever.

Vanne à boisseau sphérique équerre M/F avec écrou libre, pour chauffe eau, série GASTRONG, aux normes UNI C.I.G., poignée aluminium jaune.



Codice Code	Misura Size Dimensions		
3450 015	1/2" x 1/2"	30	120
3450 020	1/2" x 3/4"	20	80

3440 MET

RUBINETTO A SFERA A SQUADRA, ATTACCO M 1/2", CON PORTAGOMMA PER TUBO UNI 7141-13, SERIE GASTRONG, A NORME UNI C.I.G. 7141-72. LEVA ALLUMINIO GIALLA.

Angle ball bibcock M 1/2", with hose union, GASTRONG series; to UNI CIG 7141-72. Yellow aluminium lever.

Vanne à boisseau sphérique équerre M 1/2" avec raccord au nez pour tube UNI 7141-13, série GASTRONG, aux normes UNI C.I.G. 7141-72, poignée aluminium jaune.



Codice Code	Misura Size Dimensions		
3440 014	1/2" x 13 MET	30	120

3440 GPL

RUBINETTO A SFERA A SQUADRA, ATTACCO M 1/2", CON PORTAGOMMA PER TUBO UNI 7141-13, SERIE GASTRONG, A NORME UNI C.I.G. 7141-72. LEVA ALLUMINIO GIALLA.

Angle ball bibcock M 1/2", with hose union, GASTRONG series; to UNI CIG 7141-72. Yellow aluminium lever.

Vanne à boisseau sphérique équerre M 1/2" avec raccord au nez pour tube UNI 7141-13, série GASTRONG, aux normes UNI C.I.G. 7141-72, poignée aluminium jaune.



Codice Code	Misura Size Dimensions		
3440 009	1/2" x 8 GPL	30	120

3470

RUBINETTO A SFERA A SQUADRA, ATTACCO M/F 1/2". SERIE GASTRONG, A NORME UNI C.I.G. LEVA ALLUMINIO GIALLA.

Angle ball bibcock M/F, 1/2", GASTRONG series; to UNI CIG. Yellow aluminium lever.

Vanne à boisseau sphérique équerre M/F 1/2", série GASTRONG, aux normes UNI C.I.G., poignée aluminium jaune.



Codice Code	Misura Size Dimensions		
3470 015	1/2" x 1/2"	30	120

3460

RUBINETTO A SFERA A SQUADRA, ATTACCO F/F 1/2". SERIE GASTRONG, A NORME UNI C.I.G. LEVA ALLUMINIO GIALLA.

Angle ball bibcock F/F, 1/2", GASTRONG series; to UNI CIG. Yellow aluminium lever.

Vanne à boisseau sphérique équerre F/F 1/2", série GASTRONG, aux normes UNI C.I.G., poignée aluminium jaune.

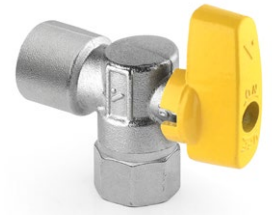

Codice Code	Misura Size Dimensions		
3460 015	1/2" x 1/2"	30	120

3445 1/2"

RUBINETTO A SFERA A SQUADRA, ATTACCO F/F 1/2" CON CALOTTA LIBERA, PER SCALDABAGNO, SERIE GASTRONG, A NORME UNI C.I.G. LEVA ALLUMINIO GIALLA.

Angle ball bibcock F/F 1/2", swivel end, for water heaters, GASTRONG series; to UNI CIG. Yellow aluminium lever.

Vanne à boisseau sphérique équerre F/F 1/2" avec écrou libre, pour chauffe eau, série GASTRONG, aux normes UNI C.I.G., poignée aluminium jaune.



Codice Code	Misura Size Dimensions		
3445 015	1/2" x 1/2"	30	120

3445 3/4"

RUBINETTO A SFERA A SQUADRA, ATTACCO F/F 3/4" CON CALOTTA LIBERA, PER SCALDABAGNO, SERIE GASTRONG, A NORME UNI C.I.G. LEVA ALLUMINIO GIALLA.

Angle ball bibcock F/F 3/4", swivel end, for water heaters, GASTRONG series; to UNI CIG. Yellow aluminium lever.

Vanne à boisseau sphérique équerre F/F 3/4" avec écrou libre, pour chauffe eau, série GASTRONG, aux normes UNI C.I.G., poignée aluminium jaune.



Codice Code	Misura Size Dimensions		
3445 020	1/2" x 3/4"	20	80

3400 MET

RUBINETTO A SFERA DIRITTO ATTACCO F 1/2" CON PORTAGOMMA, SERIE GASTRONG, A NORME UNI C.I.G. 7141-72. LEVA ALLUMINIO GIALLA.

Straight ball bibcock 1/2"F, with hose union, GASTRONG series; to UNI CIG 7141-72. Yellow aluminium lever.

Vanne à boisseau sphérique droit F 1/2" avec raccord au nez, série GASTRONG, aux normes UNI C.I.G. 7141-72, poignée aluminium jaune.



Codice Code	Misura Size Dimensions		
3400 014	1/2" x 13 MET	30	120

3400 GPL

RUBINETTO A SFERA DIRITTO ATTACCO F 1/2" CON PORTAGOMMA, SERIE GASTRONG, A NORME UNI C.I.G. 7141-72. LEVA ALLUMINIO GIALLA.

Straight ball bibcock 1/2"F, with hose union, GASTRONG series; to UNI CIG 7141-72. Yellow aluminium lever.

Vanne à boisseau sphérique droit F 1/2" avec raccord au nez, série GASTRONG, aux normes UNI C.I.G. 7141-72, poignée aluminium jaune.



Codice Code	Misura Size Dimensions		
3400 009	1/2" x 8 GPL	30	120

3410 MET

RUBINETTO A SFERA DIRITTO ATTACCO M 1/2" CON PORTAGOMMA, SERIE GASTRONG, A NORME UNI C.I.G. 7141-72. LEVA ALLUMINIO GIALLA.

Straight ball bibcock 1/2" M, with hose union, GASTRONG series; to UNI CIG 7141-72. Yellow aluminium lever.

Vanne à boisseau sphérique droit M 1/2" avec raccord au nez, série GASTRONG, aux normes UNI C.I.G. 7141-72, poignée aluminium jaune.

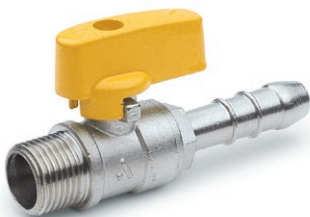

Codice Code	Misura Size Dimensions		
3410 014	1/2" x 13 MET	30	120

3410 GPL

RUBINETTO A SFERA DIRITTO ATTACCO M 1/2" CON PORTAGOMMA, SERIE GASTRONG, A NORME UNI C.I.G. 7141-72. LEVA ALLUMINIO GIALLA.

Straight ball bibcock 1/2" M, with hose union, GASTRONG series; to UNI CIG 7141-72. Yellow aluminium lever.

Vanne à boisseau sphérique droit M 1/2" avec raccord au nez, série GASTRONG, aux normes UNI C.I.G. 7141-72, poignée aluminium jaune.

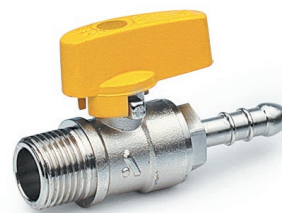

Codice Code	Misura Size Dimensions		
3410 009	1/2" x 8 GPL	30	120

3415

RUBINETTO A SFERA DIRITTO, ATTACCO F/F, CON CALOTTA LIBERA, PER SCALDABAGNO, SERIE GASTRONG, A NORME UNI C.I.G. LEVA ALLUMINIO GIALLA.

Straight ball bibcock F/F, swivel end, for water heaters, GASTRONG series; to UNI CIG. Yellow aluminium lever.

Vanne à boisseau sphérique droit F/F avec écrou libre, pour chauffe eau, série GASTRONG, aux normes UNI C.I.G., poignée aluminium jaune.

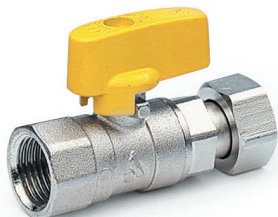

Codice Code	Misura Size Dimensions		
3415 015	1/2" x 1/2"	30	120
3415 020	1/2" x 3/4"	30	120

3418

RUBINETTO A SFERA DIRITTO, ATTACCO F (GIRELLO) / M, CON CALOTTA LIBERA, PER SCALDABAGNO, SERIE GASTRONG, A NORME UNI C.I.G. LEVA ALLUMINIO GIALLA.

Straight ball bibcock M/F, swivel end, for water heaters, GASTRONG series; to UNI CIG. Yellow aluminium lever.

Vanne à boisseau sphérique droit F/M avec écrou libre, pour chauffe eau, série GASTRONG, aux normes UNI C.I.G., poignée aluminium jaune.



Codice Code	Misura Size Dimensions		
3418 015	1/2" x 1/2"	30	120
3418 020	1/2" x 3/4"	30	120

3420

RUBINETTO A SFERA DIRITTO, ATTACCO M/M 1/2", SERIE GASTRONG, A NORME UNI C.I.G. LEVA ALLUMINIO GIALLA.

Straight ball bibcock M/M 1/2", GASTRONG series; to UNI CIG. Yellow aluminium lever.

Vanne à boisseau sphérique droit M/M 1/2", série GASTRONG, aux normes UNI C.I.G., poignée aluminium jaune.



Codice Code	Misura Size Dimensions		
3420 015	1/2" x 1/2"	30	120

3425

RUBINETTO A SFERA DIRITTO, ATTACCO F/F 1/2", SERIE GASTRONG, A NORME UNI C.I.G. LEVA ALLUMINIO GIALLA.

Straight ball bibcock F/F 1/2", GASTRONG series; to UNI CIG. Yellow aluminium lever.

Vanne à boisseau sphérique droit F/F 1/2", série GASTRONG, aux normes UNI C.I.G., poignée aluminium jaune.



Codice Code	Misura Size Dimensions		
3425 015	1/2" x 1/2"	30	120

COMPONENTI IDRICI

Hydronic components

Composants hydrauliques

FILTRI

Filter Filtres

VALVOLE DI RITEGNO

Check-valve Soupapes

VALVOLE A CLAPET

Swing pattern valve Clapet à battants

SARACINESCHE

Gate valve Vannes à passage direct

RIDUTTORI DI PRESSIONE

Pressure reducers Réducteurs de pression

GRUPPI DI ALIMENTAZIONE

Filling valve Groupes alimentation

FILTRI

Filter

Filtres

RACCOGLITORE DI IMPURITÀ A "Y" IN OTTONE STAMPATO E SABBIATO.

- FILTRO INTERNO IN ACCIAIO INOX AISI304
- TENUTA PTFE
- FILETTATURE SECONDO UNI ISO 228/1
- LIMITI DI PRESSIONE 16 BAR (PN 16)
- LIMITI DI TEMPERATURA -20 +120 °C

"Y" strainer of impurities in forged and sandblasted brass.

- Internal filter in AISI304 stainless steel
- PTFE seal
- Threads according to UNI ISO 228/1
- Pressure limits 16 bar (PN 16)
- Temperature range -20 +120 °C

Filtre "Y" d'impureté en laiton forgé et sablé.

- Filtre interne en acier inoxydable AISI304
- Joint PTFE
- Filetages selon UNI ISO 228/1
- Limites de pression 16 bar (PN 16)
- Limites de température -20 +120 °C

4500

RACCOGLITORE DI IMPURITÀ A "Y" IN OTTONE CON FILTRO INOX.

Brass, "Y" pattern filter, with stainless steel filter.

Filtre d'impureté en Y en laiton avec filtre en acier inox.



ACS

Codice Code	Misura Size	Dimensions		
4500 015	1/2"		40	160
4500 020	3/4"		25	100
4500 025	1"		20	80
4500 032	1"1/4		8	32
4500 040	1"1/2		5	20
4500 050	2"		3	12
4500 065	2"1/2		1	10
4500 080	3"		1	6
4500 100	4"		1	3

4560

RACCOGLITORE DI IMPURITÀ A "Y" IN OTTONE CON FILTRO INOX E CARTUCCIA MAGNETICA.

Brass, "Y" pattern filter, with stainless steel filter and MAGNETIC cartridge.

Filtre d'impureté en Y en laiton avec filtre en acier inox et cartouche MAGNÉTIQUE.



Codice Code	Misura Size	Dimensions	MAG		
4560 020	3/4"		4000 Gauss	1	34
4560 025	1"		4000 Gauss	1	34

4580

RACCOGLITORE DI IMPURITÀ A "Y" IN OTTONE CON FILTRO INOX E VALVOLA DI SPURGO.

Brass, "Y" pattern filter, with stainless steel filter and drain-off valve.

Filtre d'impureté en Y en laiton avec filtre en acier inox et purgeur.



ACS

Codice Code	Misura Size	Dimensions		
4580 015	1/2"		30	120
4580 020	3/4"		20	80
4580 025	1"		15	60
4580 032	1"1/4		7	28
4580 040	1"1/2		5	20
4580 050	2"		3	12

4585

RACCOGLITORE DI IMPURITÀ A "Y" IN OTTONE CON FILTRO INOX E VALVOLA DI SPURGO.

Brass, "Y" pattern filter, with stainless steel filter and drain-off valve.

Filtre d'impureté en Y en laiton avec filtre en acier inox et purgeur.



ACS

Codice Code	Misura Size	Dimensions		
4585 015	1/2"		30	120
4585 020	3/4"		20	80
4585 025	1"		15	60
4585 032	1"1/4		7	28
4585 040	1"1/2		5	20
4585 050	2"		3	12

VALVOLE DI RITEGNO

Check valve

Soupapes

7040

VALVOLA DI RITEGNO UNIVERSALE F/F, ISO 228, CON INSERTO IN OTTONE.

Universal check valve F/F, with brass inner disk.

Soupape universelle F/F, ISO 228 avec insert en laiton.



ACS

Codice Code	Misura Size	Dimensions	PN		
7040 015	1/2"		25	30	120
7040 020	3/4"		25	20	80
7040 025	1"		25	12	48
7040 032	1"1/4		16	8	32
7040 040	1"1/2		16	6	24
7040 050	2"		16	3	18
7040 065	2" 1/2		10	1	8
7040 080	3"		10	1	5
7040 100	4"		10	1	4

7050

VALVOLA DI RITEGNO SERIE PLANET, FILETTI F ISO 228, CON FILTRO ACCIAIO INOX.

Foot valve female ISO 228, with stainless steel filter, PLANET series.

Soupape série PLANET, filetage F ISO 228 avec filtre en acier inox.

PN 10



ACS

Codice Code	Misura Size	Dimensions		
7050 015	1/2"		40	160
7050 020	3/4"		25	100
7050 025	1"		15	60
7050 032	1"1/4		9	36
7050 040	1"1/2		7	28
7050 050	2"		1	20
7050 065	2" 1/2		1	9
7050 080	3"		1	6
7050 100	4"		1	3

7000

VALVOLA DI RITEGNO UNIVERSALE F/F, ISO 228, IN OTTONE, CON INSERTO IN PLASTICA.

Universal check valve F/F, made of brass, with plastic disk.

Soupape universelle F/F, ISO 228 en laiton, avec insert en plastique.

PN 10



ACS

Codice Code	Misura Size	Dimensions		
7000 015	1/2"		50	200
7000 020	3/4"		30	120
7000 025	1"		20	80
7000 032	1"1/4		15	60
7000 040	1"1/2		12	48
7000 050	2"		6	24
7000 065	2"1/2		1	9
7000 080	3"		1	8
7000 100	4"		1	6

7045

VALVOLA DI RITEGNO UNIVERSALE F/F, ISO 228, CON INSERTO IN OTTONE.

Universal check valve F/F, with brass inner disk.

Soupape universelle F/F, ISO 228 avec insert en laiton.

PN 10



ACS

Codice Code	Misura Size	Dimensions		
7045 015	1/2"		45	180
7045 020	3/4"		30	120
7045 025	1"		25	100
7045 032	1"1/4		15	60
7045 040	1"1/2		8	32
7045 050	2"		6	24

7110

FILTRO IN ACCIAIO INOX CON RACCORDO IN NYLON.

Stainless steel filter with nylon thread.

Filtre en acier inox avec raccord en nylon.

PN 10



Codice Code	Misura Size	Dimensions		
7110 015	1/2"		80	320
7110 020	3/4"		50	200
7110 025	1"		30	120
7110 032	1"1/4		24	96
7110 040	1"1/2		15	60
7110 050	2"		8	32
7110 065	2" 1/2		1	30
7110 080	3"		1	20
7110 100	4"		1	8

VALVOLE A CLAPET E SARACINESCHE

Swing pattern valve and gate valve

Clapet à battants et vannes à passage direct

7150

VALVOLA A CLAPET IN OTTONE F/F, ISO 228, CON SEDE IN GOMMA.

Swing pattern valve F/F ISO 228, with rubber seat.

Clapet à battants en laiton F/F, ISO 228 avec siège en caoutchouc.

PN 10



ACS

Codice Code	Misura Size	Dimensions		
7150 015	1/2"		16	160
7150 020	3/4"		30	120
7150 025	1"		16	64
7150 032	1"1/4		10	40
7150 040	1"1/2		6	24
7150 050	2"		5	20
7150 065	2"1/2		1	9
7150 080	3"		1	6
7150 100	4"		1	4

7200

VALVOLA DI FONDO IN OTTONE, CON SUCCHIERUOLA E TENUTA IN GOMMA.

Brass foot valve, with strainer rubber disc.

Clapet crépine de pied en laiton, joint en caoutchouc.

PN 10



3

Codice Code	Misura Size	Dimensions		
7200 015	1/2"		45	180
7200 020	3/4"		35	140
7200 025	1"		25	100
7200 032	1"1/4		11	44
7200 040	1"1/2		8	32
7200 050	2"		6	24
7200 065	2"1/2		1	20
7200 080	3"		1	12
7200 100	4"		1	5

4650

SARACINESCA IN OTTONE F/F, PASSAGGIO TOTALE.

Brass gate valve F/F, full way passage.

Vanne à passage direct en laiton F/F, passage intégral.

PN 16



ACS

Codice Code	Misura Size	Dimensions		
4650 015	1/2"		20	80
4650 020	3/4"		15	60
4650 025	1"		8	48
4650 032	1"1/4		2	24
4650 040	1"1/2		2	24
4650 050	2"		3	12
4650 065	2" 1/2		2	12
4650 080	3"		2	8
4650 100	4"		1	6

RIDUTTORI DI PRESSIONE E GRUPPI DI ALIMENTAZIONE

Pressure reducers and filling valves

Réducteurs de pression et Groupes alimentation



SI CONSIGLIA DI UTILIZZARE IL FILTRO 4500 (PAG. 39) PRIMA DEL DISPOSITIVO.
We recommend using the filter 4500 (pag. 39) before the device.
Nous vous recommandons d'utiliser le filtre 4500 (pag. 39) avant de l'appareil.

5500M

RIDUTTORE DI PRESSIONE MIGNON, ATTACCO F/F. PRESSIONE MASSIMA A MONTE 10 BAR, PRESSIONE MASSIMA A VALLE 4 BAR. RAPPORTO DI RIDUZIONE 10/1.

Brass pressure reducer Mignon series, F/F. Max upstream pressure 10 bar, max downstream pressure 4 bar. Reduction ratio 10/1.

Réducteur de pression mignon F/F. Pression maximale en amont 10Bar. Pression maximale en aval 4Bar. Rapport de réduction 10/1.

PN 10 - 80°C



Codice Code	Misura Size	Dimensions	☐	📦
5500M 015	1/2"		1	54
5500M 020	3/4"		1	50

5530

RIDUTTORE DI PRESSIONE STANDARD PER ACQUA, ATTACCO F/F CON BOCCHETTONI. PRESSIONE MASSIMA A MONTE 25 BAR, PRESSIONE MASSIMA A VALLE 6 BAR. RAPPORTO DI RIDUZIONE 10/1.

Standard brass pressure reducer for water F/F with tail. Max upstream pressure 25 bar, max downstream pressure 6 bar. Reduction ratio 10/1.

Réducteur de pression standard pour eau F/F avec goulottes. Pression maximale en amont 25Bar. Pression maximale en aval 6Bar. Rapport de réduction 10/1.

PN 25 - 80°C



Codice Code	Misura Size	Dimensions	☐	📦
5530 015	1/2"		1	32
5530 020	3/4"		1	20
5530 025	1"		1	20
5530 032	1"1/4		1	10
5530 040	1"1/2		1	10
5530 050	2"		1	6

650 - 650M

GRUPPO DI ALIMENTAZIONE AUTOMATICO.

Automatic filling valve.

Groupe d'alimentation automatique.



Codice Code	Misura Size	Dimensions	☐	📦
650 015	1/2" senza manometro/without manometer/sans manomètre		1	50
650M 015	1/2" con manometro/with manometer/avec manomètre		1	50

5520

RIDUTTORE DI PRESSIONE STANDARD PER ACQUA, ATTACCO F/F. PRESSIONE MASSIMA A MONTE 25 BAR, PRESSIONE MASSIMA A VALLE 6 BAR. RAPPORTO DI RIDUZIONE 10/1.

Standard brass pressure reducer for water F/F. Max upstream pressure 25 bar, max downstream pressure 6 bar. Reduction ratio 10/1.

Réducteur de pression standard pour eau F/F. Pression maximale en amont 25Bar. Pression maximale en aval 6Bar. Rapport de réduction 10/1.

PN 25 - 80°C



Codice Code	Misura Size	Dimensions	☐	📦
5520 015	1/2"		1	32
5520 020	3/4"		1	20
5520 025	1"		1	20
5520 032	1"1/4		1	10
5520 040	1"1/2		1	10
5520 050	2"		1	6

5540

RIDUTTORE DI PRESSIONE STANDARD PER ACQUA, ATTACCO M/M. PRESSIONE MASSIMA A MONTE 25 BAR, PRESSIONE MASSIMA A VALLE 6 BAR. RAPPORTO DI RIDUZIONE 10/1.

Standard brass pressure reducer for water, M/M. Max upstream pressure 25 bar, max downstream pressure 6 bar. Reduction ratio 10/1.

Réducteur de pression standard pour eau M/M. Pression maximale en amont 25Bar. Pression maximale en aval 6Bar. Rapport de réduction 10/1.

PN 25 - 80°C



Codice Code	Misura Size	Dimensions	☐	📦
5540 015	1/2"		1	24
5540 020	3/4"		1	32
5540 025	1"		1	20
5540 032	1"1/4		1	10
5540 040	1"1/2		1	10
5540 050	2"		1	5

RUBINETTI SOTTOLAVABO E ATTACCO LAVATRICE

*Under-wash basin tap and
washing machine tap*

*Robinets d'arrêt pour lavabo et
robinets pour machine à laver*

RUBINETTI SOTTOLAVABO

Design under-wash basin tap Robinets d'arrêt décoratif pour lavabo

PRESE ACQUA D'ARREDO

Water connections Sortie d'eau

RUBINETTI COMBINATI A 3 VIE

Under-wash basin tap 3 ways Robinet d'arrêt 3 voies

RUBINETTI ATTACCO LAVATRICE

Washing machine tap Robinets pour machine à laver

RUBINETTI SOTTOLAVABO E PRESE ACQUA D'ARREDO

Design *under-wash* basin tap and *water connections*

Robinets d'arrêt décoratif *pour lavabo* et *sortie d'eau*

2601

TONDO RUBINETTO SOTTOLAVABO IN OTTONE CROMATO CON VITONE CERAMICO E FILTRO. ROSONE TIPO PESANTE.

ROUND under-wash basin made in chrome-plated brass with ceramic core and filter. Heavy type rosette.

ROND robinet d'arrêt en laiton chromé avec cartouche céramique avec filtre en acier inox. Rosette modèle lourd.

PN 10



Codice Code	Misura Size	Dimensions		
2601 01510	1/2" x 3/8"		2	36

2701

QUADRO RUBINETTO SOTTOLAVABO IN OTTONE CROMATO CON VITONE CERAMICO E FILTRO. ROSONE TIPO PESANTE.

SQUARE under-wash basin made in chrome-plated brass with ceramic core and filter. Heavy type rosette.

CARRE robinet d'arrêt en laiton chromé avec cartouche céramique avec filtre en acier inox. Rosette modèle lourd.

PN 10

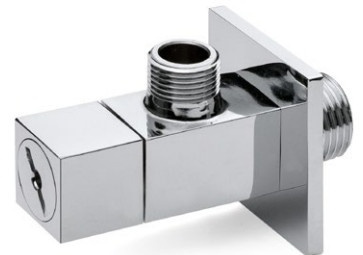

Codice Code	Misura Size	Dimensions		
2701 01510	1/2" x 3/8"		2	36

CHIUSURA DI SICUREZZA

Sistema di svitamento del filtro in senso orario per garantire la chiusura del rubinetto ed il bloccaggio del flusso d'acqua.

SAFETY CLOSURE

Filter unscrewing system in clockwise direction to guarantee the closing of the tap and the blocking of the water flow.

FERMETURE DE SÉCURITÉ

Système de dévissage de filtre dans le sens horaire pour garantir la fermeture du robinet et le blocage du débit d'eau.

SVITAMENTO IN SENSO ORARIO
UNSCREWING CLOCKWISE
DEVISSAGE DANS LE SENS HORAIRE



SVITAMENTO IN SENSO ORARIO
UNSCREWING CLOCKWISE
DEVISSAGE DANS LE SENS HORAIRE



2651

TONDO RUBINETTO SOTTOLAVABO IN OTTONE CROMATO CON VITONE CERAMICO. ROSONE TIPO PESANTE.

ROUND under-wash basin made in chrome-plated brass with ceramic core. Heavy type rosette.

ROND robinet d'arrêt en laiton chromé avec cartouche céramique. Rosette modèle lourd.

PN 10



Codice Code	Misura Size Dimensions		
2651 01510	1/2" x 3/8"	2	36

2751

QUADRO RUBINETTO SOTTOLAVABO IN OTTONE CROMATO CON VITONE CERAMICO. ROSONE TIPO PESANTE.

SQUARE under-wash basin made in chrome-plated brass with ceramic core. Heavy type rosette.

CARRE robinet d'arrêt en laiton chromé avec cartouche céramique. Rosette modèle lourd.

PN 10

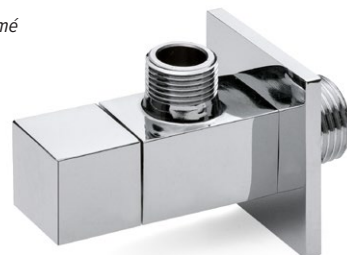

Codice Code	Misura Size Dimensions		
2751 01510	1/2" x 3/8"	2	36

2680

TONDO PRESA ACQUA IN OTTONE CROMATO CON ROSONE MODELLO PESANTE.

ROUND chromed brass water connection with heavy type rosette.

ROND sortie d'eau en laiton chromé avec rosette modèle lourd.



Codice Code	Misura Size Dimensions		
2680 01515	1/2" x 1/2"	1	72

2780

QUADRO PRESA ACQUA IN OTTONE CROMATO CON ROSONE MODELLO PESANTE.

SQUARE chromed brass water connection with heavy type rosette.

CARRE sortie d'eau en laiton chromé avec rosette modèle lourd.



Codice Code	Misura Size Dimensions		
2780 01515	1/2" x 1/2"	1	72

2685

TONDO PRESA ACQUA IN OTTONE CROMATO CON SUPPORTO DOCCETTA E ROSONE MODELLO PESANTE.

ROUND chromed brass water connection with shower holder and heavy type rosette.

ROND sortie d'eau en laiton chromé avec support de douche et rosette modèle lourd.



Codice Code	Misura Size Dimensions		
2685 01515	1/2" x 1/2"	1	56

2785

QUADRO PRESA ACQUA IN OTTONE CROMATO CON SUPPORTO DOCCETTA E ROSONE MODELLO PESANTE.

SQUARE chromed brass water connection with shower holder and heavy type rosette.

CARRE sortie d'eau en laiton chromé avec support de douche et rosette modèle lourd.



Codice Code	Misura Size Dimensions		
2785 01515	1/2" x 1/2"	1	56

RUBINETTI SOTTOLAVABO A SFERA

Under-wash basin ball tap

Robinets d'arrêt à sphère pour lavabo

RUBINETTO A SFERA SOTTOLAVABO IN OTTONE STAMPATO E CROMATO.

- ASTA IN OTTONE MONTATA DALL'INTERNO CONTRO LE MANOMISSIONI E/O L'ESTRAZIONE E ANTISCOPPIO
- SFERA IN OTTONE DIAMANTATA E CROMATA
- SEDI IN PTFE O ORING
- LEVA IN METALLO O PLASTICA
- ROSONE IN ACCIAIO INOX
- FILETTATURE SECONDO ISO 228/1
- LIMITI DI PRESSIONE 10 BAR (PN 10)
- LIMITI DI TEMPERATURA -10 +100 °C

Under-wash basin ball tap made of forged brass and chrome plated.

- Brass stem assembled from inside to avoid tampering, extraction or explosion
- Brass solid ball with cleaned and chromium plated surface
- PTFE or O-ring seats
- Lever made of metal or plastic
- Inox rosette
- Threads according to ISO 228/1
- Pressure limits 10 bar (PN 10)
- Temperature range -10 +100 °C

Robinet d'arrêt à sphère en laiton matricé chromé.

- Tige en laiton montée de l'intérieur contre les altérations et/ou l'extraction et anti éclat
- Sphère diamantée et chromée
- Sièges en PTFE ou O-ring
- Poignée métal ou plastique
- Rosace en acier inoxydable
- Filetages selon ISO 228/1
- Limites de pression 10 bar (PN 10)
- Limites de température -10 +100 °C



LEVETTA CROMATA IN METALLO.
Metal chromium plated handle.
Poignée en métal chromée.

2520

RUBINETTO A SFERA SOTTOLAVABO IN OTTONE CROMATO, CON FILTRO INOX, SNODO E ROSONE.

Under-wash basin ball tap made of brass, chromium plated, with stainless steel filter, articulation and flange.

Robinet d'arrêt à sphère en laiton chromé avec filtre en acier inox, articulation et rosace.



Codice	Code	Misura	Size	Dimensions		
2520	01510		1/2"	x 3/8" Ø10	25	100

2522

RUBINETTO A SFERA SOTTOLAVABO IN OTTONE CROMATO, CON FILTRO INOX, SNODO E ROSONE. MODELLO COMPATTO.

Under-wash basin ball tap made of brass, chromium plated, with stainless steel filter, articulation and flange. Compact model.

Robinet d'arrêt à sphère en laiton chromé avec filtre en acier inox, articulation et rosace. Modèle compact.



Codice	Code	Misura	Size	Dimensions		
2522	01510		1/2"	x 3/8" Ø10	25	100

2524

RUBINETTO A SFERA SOTTOLAVABO IN OTTONE CROMATO CON FILTRO INOX, SNODO E ROSONE. TENUTA O-RING. MODELLO COMPATTO.

Under-wash basin ball tap made of brass, chromium plated, with stainless steel filter, articulation and flange. O-ring seal. Compact model.

Robinet d'arrêt à sphère en laiton chromé avec filtre en acier inox, articulation et rosace. Étanchéité o-ring. Modèle compact.



Codice	Code	Misura	Size	Dimensions		
2524	01510		1/2"	x 3/8" Ø10	25	100

2500

RUBINETTO A SFERA SOTTOLAVABO IN OTTONE CROMATO, CON FILTRO INOX, DADO E ROSONE.

Under-wash basin ball tap made of brass, chromium plated, with stainless steel filter, nut and flange.

Robinet d'arrêt à sphère en laiton chromé avec filtre en acier inox, écrou et rosace.



Codice Code	Misura Size Dimensions		
2500 01510	1/2" x 3/8" Ø10	25	100

2501

RUBINETTO A SFERA SOTTOLAVABO IN OTTONE CROMATO, CON FILTRO INOX, CON ROSONE, SENZA DADO.

Under-wash basin ball tap made of brass, chromium plated, with stainless steel filter, with flange, without nut.

Robinet d'arrêt à sphère en laiton chromé avec filtre en acier inox, avec rosace, sans écrou.



Codice Code	Misura Size Dimensions		
2501 01510	1/2" x 3/8"	25	100

040F

RUBINETTO A SFERA A SQUADRA 10x1/2" E 15x1/2", CROMATO, CON ROSONE E CON DADO.

Angle ball cock 10x1/2" and 15x1/2" made of brass, chromium plated, with nut and flange.

Robinet à sphère équerre 10x1/2" et 15x1/2", chromé avec rosace et écrou.



Codice Code	Misura Size Dimensions		
040F 01510	1/2" x 3/8" Ø10	2	128

045F

RUBINETTO A SFERA A SQUADRA 10x1/2" E 15x1/2", CROMATO, CON ROSONE, SENZA DADO.

Angle ball cock 10x1/2" and 15x1/2" made of brass, chromium plated, with flange, without nut.

Robinet à sphère équerre 10x1/2" et 15x1/2", chromé avec rosace, sans écrou.



Codice Code	Misura Size Dimensions		
045F 01510	1/2" x 3/8"	2	128
045F 01515	1/2" x 1/2"	2	128

RUBINETTI SOTTOLAVABO A VITONE

Under-wash headwork tap

Robinets d'arrêt avec tête pour lavabo

RUBINETTO A VITONE SOTTOLAVABO IN OTTONE STAMPATO E CROMATO.

- VITONE CON DOPPIO O-RING DI TENUTA
- GUARNIZIONE DI CHIUSURA IN GOMMA NBR
- LEVA IN PLASTICA
- ROSONE IN ACCIAIO INOX
- FILETTATURE SECONDO ISO 228/1
- LIMITI DI PRESSIONE 10 BAR (PN 10)
- LIMITI DI TEMPERATURA -10 +100 °C

Under-wash basin headwork tap made of forged brass and chrome plated.

- *Headwork with double O-ring seal*
- *NBR rubber sealing gasket*
- *Lever made of plastic*
- *Inox rosette*
- *Threads according to ISO 228/1*
- *Pressure limits 10 bar (PN 10)*
- *Temperature range -10 +100 °C*

Robinet d'arrêt avec tête en laiton matricé chromé.

- *Tige avec double joint torique*
- *Joint d'étanchéité en caoutchouc NBR*
- *Poignée plastique*
- *Rosace en acier inoxydable*
- *Filetages selon ISO 228/1*
- *Limites de pression 10 bar (PN 10)*
- *Limites de température -10 +100 °C*

2530

RUBINETTO A VITONE SOTTOLAVABO IN OTTONE CROMATO, CON FILTRO INOX, SNODO E ROSONE.

Under-wash basin headwork tap made of brass, chromium plated, with stainless steel filter, articulation and flange.

Robinet d'arrêt avec tête en laiton chromé avec filtre en acier inox, articulation et rosace.



Codice Code	Misura Size	Dimensions		
2530 01510	1/2" x 3/8"	Ø10	20	80

2532

RUBINETTO A VITONE SOTTOLAVABO IN OTTONE CROMATO, CON FILTRO INOX, SNODO E ROSONE. MODELLO COMPATTO.

Under-wash basin headwork tap made of brass, chromium plated, with stainless steel filter, articulation and flange. Compact model.

Robinet d'arrêt avec tête en laiton chromé avec filtre en acier inox, articulation et rosace. Modèle compact.



Codice Code	Misura Size	Dimensions		
2532 01510	1/2" x 3/8"	Ø10	20	80

2531

RUBINETTO A VITONE SOTTOLAVABO IN OTTONE CROMATO, CON FILTRO INOX, SENZA DADO. MODELLO COMPATTO.

Under-wash basin headwork tap made of brass, chromium plated, with stainless steel filter, without nut. Compact model.

Robinet d'arrêt avec tête en laiton chromé avec filtre en acier inox, sans écrou. Modèle compact.



Codice Code	Misura Size	Dimensions		
2531 01510	1/2" x 3/8"		25	100

050

RUBINETTO CON VITONE A SQUADRA 10x1/2", CROMATO, CON ROSONE E CON DADO.

Angle headwork cock 10x1/2" made of brass, chromium plated, with nut and flange.

Robinet à équerre avec tête 10x1/2", chromé avec rosace et écrou.



Codice Code	Misura Size Dimensions		
050 01510	1/2" x 3/8" Ø10	1	80



055

RUBINETTO CON VITONE A SQUADRA 10x1/2", CROMATO, CON ROSONE, SENZA DADO.

Angle headwork cock 10x1/2" made of brass, chromium plated, with flange, without nut.

Robinet à équerre avec tête 10x1/2", chromé avec rosace, sans écrou.



Codice Code	Misura Size Dimensions		
055 01510	1/2" x 3/8"	25	100
055 01515	1/2" x 1/2"	25	100
055 01520	1/2" x 3/4"	25	100

RUBINETTI COMBINATI A 3 VIE

Under-wash basin tap 3 ways

Robinet d'arrêt 3 voies

4

2550

RUBINETTO COMBINATO 3 VIE CON VALVOLA DI RITEGNO E ATTACCO LAVATRICE. IN OTTONE CROMATO, DADO E ROSONE.

Under-wash basin tap 3 ways with washing machine connection and check valve. Made of brass, chromium plated.

Robinet d'arrêt 3 voies avec clapet anti-retour et connexion pour machine à laver en laiton chromé, écrou et rosace.

PN 10



Codice Code	Misura Size Dimensions		
2550 01520	1/2" x 3/4" Ø10	12	48

2558

RUBINETTO COMBINATO 3 VIE A VITONE CON FILTRO. IN OTTONE CROMATO, DADO E ROSONE.

Under-wash basin filter tap 3 ways with washing machine connection. Made of brass, chromium plated.

Robinet d'arrêt 3 voies avec filtre et connexion pour machine à laver en laiton chromé, écrou et rosace.

PN 10



Codice Code	Misura Size Dimensions		
2558 01520	1/2" x 3/4" Ø10	1	50

RUBINETTI ATTACCO LAVATRICE

Washing machine tap

Robinets pour machine à laver

RUBINETTO A SFERA LAVATRICE IN OTTONE STAMPATO E CROMATO.

- ASTA IN OTTONE MONTATA DALL'INTERNO CONTRO LE MANOMISSIONI E/O L'ESTRAZIONE E ANTISCOPPIO
- SFERA IN OTTONE DIAMANTATA E CROMATA
- SEDI IN PTFE
- LEVA IN METALLO O PLASTICA
- ROSONE IN ACCIAIO INOX
- FILETTATURE SECONDO ISO 228/1
- LIMITI DI PRESSIONE 10 BAR (PN 10)
- LIMITI DI TEMPERATURA -10 +90 °C

Chromium plated washing machine tap made of forged brass and chrome plated.

- Brass stem assembled from inside to avoid tampering, extraction or explosion
- Brass solid ball with cleaned and chromium plated surface
- PTFE seats
- Lever made of plastic
- Inox rosette
- Threads according to ISO 228/1
- Pressure limits 10 bar (PN 10)
- Temperature range -10 +90 °C

Robinet à sphère chromé pour machines à laver en laiton matricé chromé.

- Tige en laiton montée de l'intérieur contre les altérations et/ou l'extraction et anti éclat
- Sphère diamantée et chromée
- Sièges en PTFE
- Poignée plastique
- Rosace en acier inoxydable
- Filetages selon ISO 228/1
- Limites de pression 10 bar (PN 10)
- Limites de température -10 +90 °C



LEVETTA CROMATA IN METALLO.
Metal chromium plated handle.
Poignée en métal chromée.

2453

RUBINETTO A SFERA CROMATO PER LAVATRICE, M/M ISO 228, CON LEVETTA CROMATA IN METALLO E ROSONE. MODELLO PESANTE.

Chromium plated washing machine tap with metal chromium plated handle and rosette. Heavy model.

Robinet à sphère chromé pour machines à laver, M/M ISO 228, avec poignée en métal chromée et rosace. Modèle lourd.



Codice Code	Misura Size Dimensions	☐	📦
2453 01520	1/2" x 3/4"	25	100

2450

RUBINETTO A SFERA CROMATO PER LAVATRICE, M/M ISO 228, CON LEVETTA CROMATA IN METALLO E ROSONE.

Chromium plated washing machine tap with metal chromium plated handle and rosette.

Robinet à sphère chromé pour machines à laver, M/M ISO 228, avec poignée en métal chromée et rosace.



Codice Code	Misura Size Dimensions	☐	📦
2450 01020	3/8" x 3/4"	25	100
2450 01515	1/2" x 1/2"	25	100
2450 01520	1/2" x 3/4"	25	100

2470

RUBINETTO A SFERA CROMATO PER LAVATRICE, SILVER, CON LEVETTA CROMATA IN METALLO E ROSONE.

Chromium plated washing machine tap SILVER, with metal chromium plated handle and rosette.

Robinet à sphère chromé pour machines à laver, SILVER, avec poignée en métal chromée et rosace.



Codice Code	Misura Size Dimensions	☐	📦
2470 01020	3/8" x 3/4"	20	80
2470 01520	1/2" x 3/4"	20	80

2490

RUBINETTO CROMATO A VITONE PER LAVATRICE, SILVER CON MANIGLIA CROMATA IN PLASTICA.

Chrome-plated headwork tap for washing machine with plastic handle.

Robinet de machine à laver chromé avec tête et poignée en plastique.



Codice Code	Misura Size Dimensions	☐	📦
2490 01520	M 1/2" x M 3/4" x F 1/2"	25	100

VALVOLE ED ACCESSORI PER CORPI SCALDANTI

Heating valves and accessories

Vannes et accessoires pour corps chauffant



TESTE TERMOSTATICHE

Thermostatic head Installation tête thermostatique

VALVOLE H

H-valves Vannes H

TESTE TERMOSTATICHE

Thermostatic head

Tête thermostatique

CARATTERISTICHE TECNICHE TESTE TERMOSTATICHE THERMOSTATIC HEAD GENERAL FEATURES CARACTÉRISTIQUES TECHNIQUES TÊTE THERMOSTATIQUE

ISTERESI <i>Hysteresis</i> <i>Hystérésis</i>	0.60 K
PRESS. MAX. DI ESERCIZIO <i>Max. working pressure</i> <i>Pression maximale d'exercice</i>	10 bar
PRESS. MAX. DIFFERENZIALE <i>Max. differential pressure</i> <i>Pression maximale différentielle</i>	1.0 bar
TEMP. MAX. DEL FLUIDO <i>Max. fluid temperature</i> <i>Température max. du fluide</i>	110 °C
INFLUENZA DELLA TEMPERATURA DEL FLUIDO <i>Influence of the fluid temperature</i> <i>Influence de la température du fluide</i>	0.45 K
INFLUENZA DELLA PRESSIONE DIFFERENZIALE <i>Influence of differential pressure</i> <i>Influence de la pression différentielle</i>	0.60 K
CAMPO DI REGOLAZIONE <i>Regulation field</i> <i>Aire de réglage</i>	7 °C - 28 °C
TEMPO DI RISPOSTA <i>Response time</i> <i>Temps de réponse</i>	25 min.
PORTATA NOMINALE <i>Nominal flow rate</i> <i>Débit nominal</i>	190 l/h

CARATTERISTICHE TECNICHE 4 TTE 4 TTE GENERAL FEATURES CARACTÉRISTIQUES TECHNIQUES 4 TTE

TENSIONE DI ALIMENTAZIONE <i>Supply voltage</i> <i>Tension d'alimentation</i>	2x 1,5 V LR6/Mignon/AA
ASSORBIMENTO DI CORRENTE <i>Current absorption</i> <i>Absorption de courant</i>	100 mA (max)
DURATA DELLA BATTERIA <i>Battery life</i> <i>Vie de la batterie</i>	3 anni (+/-)
GRADO DI PROTEZIONE <i>Degree of protection</i> <i>Degré de protection</i>	Ip20
TEMPERATURA AMBIENTE <i>Ambient temperature</i> <i>Température ambiante</i>	da 0 a 50 °C
TEMPERATURA SUPERFICIALE (AL RADIATORE) <i>Surface temperature (at the radiator)</i> <i>Température de surface (au radiateur)</i>	90 °C
COLLEGAMENTO <i>Connection</i> <i>Connexion</i>	M30 x 1,5 mm
CORSA LINEARE <i>Linear stroke</i> <i>Course linéaire</i>	4,3 mm
PESO (BATTERIE INCLUSE) <i>Weight (batteries included)</i> <i>Poids (batteries incluses)</i>	180 g
DIMENSIONI <i>Size</i> <i>Dimensions</i>	60 x 54 x 103 mm

1TR

TESTA TERMOSTATICA CON SENSORE A LIQUIDO.

Thermostatic head with liquid sensor.

Tête thermostatique avec capteur de liquide.



1TS

TESTA TERMOSTATICA CON SENSORE A LIQUIDO E BLOCCO DELLA TEMPERATURA. MODELLO COMPATTO.

Thermostatic head with liquid sensor and temperature lock. Compact model.

Tête thermostatique avec capteur liquide et bloc de température. Modèle compact.



Codice Code	Misura Size Dimensions		
1TR	M30 x 1,5	1	100

Codice Code	Misura Size Dimensions		
1TS	M30 x 1,5	1	72

1TT

TESTA TERMOSTATICA CON SENSORE A LIQUIDO E BLOCCO DELLA TEMPERATURA.

Thermostatic head with liquid sensor and temperature lock.

Tête thermostatique avec capteur liquide et bloc de température.



4 TTE

TESTA TERMOSTATICA ELETTRONICA.

Electronic thermostatic head.

Tête thermostatique électronique.



Codice Code	Misura Size Dimensions		
1TT	M30 x 1,5	1	66

Codice Code	Misura Size Dimensions		
4 TTE	M 30 x 1,5		

COD 10T

ADATTATORE PER TESTA TERMOSTATICA IN OTTONE.

Brass adaptor for thermostatic head.

Adaptateur pour tête thermostatique.



GAF 1TT

GHIERA ANTIFURTO PER TESTA TERMOSTATICA.

Anti theft device for thermostatic head.

Dispositif anti-vol pour tête thermostatique.



Codice Code	Misura Size Dimensions		
COD 10T	M 20 x 1 / M 30 x 1,5	20	500

Codice Code	Misura Size Dimensions		
GAF 1TT	M 30 x 1,5	100	500

VALVOLE H MODELLO EXPORT

H-valves export type

Vannes H modèle export

VALVOLA AD "H" IN OTTONE BITUBO IN OTTONE STAMPATO E SABBIATO.

- ASTA IN OTTONE MONTATA DALL'INTERNO CONTRO LE MANOMISSIONI E/O L'ESTRAZIONE E ANTI SCOPPIO
- TENUTA O-RINGS EPDM
- SEDI IN PTFE
- FILETTATURE SECONDO UNI ISO 228/1
- ATTACCO A COMPRESSIONE 3/4" EK
- LIMITI DI PRESSIONE 10 BAR (PN 10)
- LIMITI DI TEMPERATURA -20 +110 °C

Double pipe "H" valve in forged and sandblasted brass.

- Brass rod mounted from the inside against tampering and/or extraction and anti-burst
- EPDM O-ring seal
- PTFE seats
- Threads according to UNI ISO 228/1
- Compression fitting 3/4" EK
- Pressure limits 10 bar (PN 10)
- Temperature range -20 +110 °C

Vanne double tube "H" en laiton forgé et sablé.

- Tige en laiton montée de l'intérieur contre les manipulations et/ou l'extraction et anti-éclatement
- Joint torique EPDM
- Sièges PTFE
- Filetages selon UNI ISO 228/1
- Raccord à compression 3/4" EK
- Limites de pression 10 bar (PN 10)
- Limites de température -20 +110 °C

345CP 1/2"

VALVOLA AD H MODELLO EXPORT, DIRITTA BITUBO 1/2M.

Straight H control valve export type for double pipe system 1/2M.

Vannes modèle H-export, droite tuyau systèmes 1/2M.

PASSO 50 MM
Pitch 50mm
E.A. 50mm



Codice Code	Misura Size Dimensions		
345CP 015	1/2" x 3/4" EK	6	60

345CP 3/4"

VALVOLA AD H MODELLO EXPORT, DIRITTA BITUBO 3/4F.

Straight H control valve export type for double pipe system 3/4F.

Vannes modèle H-export, droite tuyau systèmes 3/4F.

PASSO 50 MM
Pitch 50mm
E.A. 50mm



Codice Code	Misura Size Dimensions		
345CP 020	3/4" x 3/4" EK	6	60

346CP 1/2"

VALVOLA AD H MODELLO EXPORT, ANGOLO BITUBO 1/2M.

Angle H control valve export type for double pipe system 1/2M.

Vannes modèle H-export, équerre tuyau systèmes 1/2M.

PASSO 50 MM
Pitch 50mm
E.A. 50mm



Codice Code	Misura Size Dimensions		
346CP 015	1/2" x 3/4" EK	6	60

346CP 3/4"

VALVOLA AD H MODELLO EXPORT, ANGOLO BITUBO 3/4F.

Angle H control valve export type for double pipe system 3/4F.

Vannes modèle H-export, équerre tuyau systèmes 3/4F.

PASSO 50 MM
Pitch 50mm
E.A. 50mm



Codice Code	Misura Size Dimensions		
346CP 020	3/4" x 3/4" EK	6	60

9100

ADATTATORE PER TUBO RAME. FINITURA NICHELATA.

*Adapter for copper pipe type.
Nickel finishing.*

*Raccord à compression avec joint d'étanchéité
en caoutchouc pour tube cuivre.
Finition nickelée.*



Codice	Code	Misura Size Dimensions	Per tubo For pipe Pour tube		
9100	15 020	Ø 15 x 3/4"	Ø 15 mm	80	320

9200

ADATTATORE A COMPRESSIONE CON TENUTA O-RING E ANELLO PTFE PER TUBO PEX E MULTISTRATO. FINITURA NICHELATA.

Adapter for PEX/AL-PEX. Nickel finishing.

*Raccord à compression avec O-ring et
bague en PTFE pour tube PEX et multi-
couche. Finition nickelée.*



Codice	Code	Misura Size Dimensions	Per tubo For pipe Pour tube		
9200	16 12 020	16/12 x 3/4"	16 x 2	80	320

COD345

RACCORDO M/M 3/4" x 1/2" PER VALVOLA AD H. TENUTA O-RING.

*Fittings M/M 3/4" x 1/2" for H valve.
O-ring sealing.*

*Raccords M/M 3/4" x 1/2" pour soupape de H.
Etanchéité avec O-Ring.*



Codice	Code	Misura Size Dimensions
COD345	015	3/4" x 1/2"



VALVOLE H TERMOSTATIZZABILI

Thermostatic H-valves

Vannes H thermostatisable

VALVOLA AD "H" IN OTTONE BITUBO IN OTTONE STAMPATO E SABBBIATO.

- VITONE TERMOSTATIZZABILE
- DETENTORE MICROMETRICO
- CAPPUCCIO DI PROTEZIONE IN PLASTICA
- GUARNIZIONI DI TENUTA EPDM
- FILETTATURE SECONDO UNI ISO 228/1
- ATTACCO A COMPRESSIONE 3/4" EK
- LIMITI DI PRESSIONE 10 BAR (PN 10)
- LIMITI DI TEMPERATURA -20 +100 °C

Double pipe "H" valve in forged and sandblasted brass.

- Thermostatic valve
- Micrometric lockshield
- Plastic protective cap
- EPDM seals
- Threads according to UNI ISO 228/1
- Compression fitting 3/4" EK
- Pressure limits 10 bar (PN 10)
- Temperature range -20 +100 °C

Vanne double tube "H" en laiton forgé et sablé.

- Vanne thermostatique
- Coude de réglage micrométrique
- Capuchon de protection en plastique
- Joints EPDM
- Filetages selon UNI ISO 228/1
- Raccord à compression 3/4" EK
- Limites de pression 10 bar (PN 10)
- Limites de température -20 +100 °C

343CP 1/2"

VALVOLA AD H TERMOSTATIZZABILE A SQUADRA, CON RACCORDI. FINITURA NICHELATA.

Angle H valve thermostatic, with fittings. Nickel finishing.

Vannes thermostatisable modèle H, équerre, avec raccords. Finition nickelée.

PASSO 50 MM
Pitch 50mm
E.A. 50mm



Codice	Code	Misura	Size	Dimensions		
343CP	015		1/2"	x 3/4" EK	1	30

343CP 3/4"

VALVOLA AD H TERMOSTATIZZABILE A SQUADRA, SENZA RACCORDI. FINITURA NICHELATA.

Angle H valve thermostatic, without fittings. Nickel finishing.

Vannes thermostatisable modèle H, équerre, sans raccords. Finition nickelée.

PASSO 50 MM
Pitch 50mm
E.A. 50mm



Codice	Code	Misura	Size	Dimensions		
343CP	020		3/4"	x 3/4" EK	1	30

344CP 1/2"

VALVOLA AD H TERMOSTATIZZABILE DIRITTA, CON RACCORDI. FINITURA NICHELATA.

Straight H valve thermostatic, with fittings. Nickel finishing.

Vannes thermostatisable modèle H, droite, avec raccords. Finition nickelée.

PASSO 50 MM
Pitch 50mm
E.A. 50mm



Codice	Code	Misura	Size	Dimensions		
344CP	015		1/2"	x 3/4" EK	1	30

344CP 3/4"

VALVOLA AD H TERMOSTATIZZABILE DIRITTA, SENZA RACCORDI. FINITURA NICHELATA.

Straight H valve thermostatic, without fittings. Nickel finishing.

Vannes thermostatisable modèle H, droite, sans raccords. Finition nickelée.

PASSO 50 MM
Pitch 50mm
E.A. 50mm



Codice	Code	Misura	Size	Dimensions		
344CP	020		3/4"	x 3/4" EK	1	30

9100

ADATTATORE PER TUBO RAME. FINITURA NICHELATA.

*Adapter for copper pipe type.
Nickel finishing.*

*Raccord à compression avec joint d'étanchéité
en caoutchouc pour tube cuivre.
Finition nickelée.*



Codice	Code	Misura Size Dimensions	Per tubo For pipe Pour tube		
9100	15 020	Ø 15 x 3/4"	Ø 15 mm	80	320

9200

ADATTATORE A COMPRESSIONE CON TENUTA O-RING E ANELLO PTFE PER TUBO PEX E MULTISTRATO. FINITURA NICHELATA.

Adapter for PEX/AL-PEX. Nickel finishing.

*Raccord à compression avec O-ring et
bague en PTFE pour tube PEX et multi-
couche. Finition nickelée.*



Codice	Code	Misura Size Dimensions	Per tubo For pipe Pour tube		
9200	16 12 020	16/12 x 3/4"	16 x 2	80	320

COD340

RACCORDO M/M 3/4" x 1/2" PER VALVOLA AD H.

Fittings M/M 3/4" x 1/2" for H valve.

Raccords M/M 3/4" x 1/2" pour soupape de H.



Codice	Code	Misura Size Dimensions
COD340	015	3/4" x 1/2"



5

VALVOLE D'ARREDO

Design valves

Vannes décoratif

VALVOLE D'ARREDO

Design valves Vannes décoratif

ADATTATORI

Adapters Raccords

VALVOLE D'ARREDO MODELLO EXPORT

Design valves export type Vannes décoratif modèle export

KIT COPRI TUBO

Tube cover set Kit de couvre-tuyaux

SCALDASALVIETTE

Towel Sècheserviettes

VALVOLE H TERMOSTATIZZABILI D'ARREDO

Thermostatic H-valves Vannes H thermostatisable

VALVOLE TERMOSTATIZZABILI MONOTUBO

Thermostatic valves monotube Vannes thermostatisable monotube



VALVOLE D'ARREDO **TONDE** FINITURA CROMO

Round design valves chrome finishing

Vannes décoratif rond finition chromée

KIT TERMOARREDO.

- ATTUATORE CON SENSORE A LIQUIDO
- VALVOLE IN OTTONE CROMATO
- CON VITONE TERMOSTATICO O MANUALE
- CAPPUCCHIO DI PROTEZIONE IN PLASTICA
- FILETTATURE SECONDO UNI ISO 228/1
- LIMITI DI PRESSIONE 10 BAR (PN 10)
- LIMITI DI TEMPERATURA -20 +110 °C

Radiator kit.

- Liquid sensor actuator
- Valves in chromed brass
- Valves with thermostatic or manual core
- Plastic protective cap
- Threads according to UNI ISO 228/1
- Pressure limits 10 bar (PN 10)
- Temperature range -20 +110 °C

Kit radiateur.

- Actionneur de capteur de liquide
- Vannes en laiton chromé
- Vannes à vis thermostatique ou manuelle
- Capuchon de protection en plastique
- Filetages selon UNI ISO 228/1
- Limites de pression 10 bar (PN 10)
- Limites de température -20 +110 °C

2TT CC

TESTA TERMOSTATICA CON SENSORE A LIQUIDO.

Thermostatic head with liquid sensor.

Tête thermostatique avec capteur de liquide.



Codice Code	Misura Size Dimensions
2TT CC	M 30 x 1,5

100TA

VALVOLA D'ARREDO A SQUADRA TERMOSTATIZZABILE ATTACCO A COMPRESSIONE. FINITURA CROMO.

Angle thermostatic radiator design valve compression end. Chrome finishing.

Robinet de radiateur décoratif à équerre thermostatizable, connexion à compression. Finition chromée.



Codice Code	Misura Size Dimensions
100TA 015	1/2" x 1/2"

100TAK

KIT VALVOLE D'ARREDO A SQUADRA TERMOSTATIZZABILI ATTACCO A COMPRESSIONE. FINITURA CROMO.

Kit angle thermostatic radiator design valves compression end. Chrome finishing.

Set robinets de radiateur décoratif à équerre thermostatizable, connexion à compression. Finition chromée.



Codice Code	Misura Size Dimensions
100TAK 015	1/2" x 1/2"

100KCR - 100KCM

KIT VALVOLE D'ARREDO A SQUADRA TERMOSTATIZZABILI ATTACCO A COMPRESSIONE. FINITURA CROMO.

Kit angle thermostatic radiator design valves compression end. Chrome finishing.

Set robinets de radiateur décoratif à équerre thermostatizable, connexion à compression. Finition chromée.



Codice Code	Misura Size Dimensions	Tubo pipe tube
100KC 015 R 12	1/2" x 1/2" - 9100TA incluso/included	Ø 12
100KC 015 R 15	1/2" x 1/2" - 9100TA incluso/included	Ø 15
100KC 015 M 16 12	1/2" x 1/2" - 9200TA incluso/included	16 x 2

200TA

VALVOLA D'ARREDO A SQUADRA ATTACCO A COMPRESSIONE. FINITURA CROMO.

Angle radiator design valve compression end. Chrome finishing.

Robinet de radiateur décoratif à équerre, connexion à compression. Finition chromée.



Codice Code	Misura Size Dimensions
200TA 015	1/2" x 1/2"

200KC

KIT VALVOLE D'ARREDO A SQUADRA ATTACCO A COMPRESSIONE. FINITURA CROMO.

Kit angle radiator design valves compression end. Chrome finishing.

Set robinets de radiateur décoratif à équerre, connexion à compression. Finition chromée.



Codice Code	Misura Size Dimensions
200KC 015	1/2" x 1/2" Coppia - Pair - Couple

200KCR - 200KCM

KIT VALVOLE D'ARREDO A SQUADRA ATTACCO A COMPRESSIONE. FINITURA CROMO.

Kit angle radiator design valves compression end. Chrome finishing.

Set robinets de radiateur décoratif à équerre, connexion à compression. Finition chromée.



Codice Code	Misura Size Dimensions	Tubo pipe tube
200KC 015 R 12	1/2" x 1/2" - 9100TA incluso/included	Ø 12
200KC 015 R 15	1/2" x 1/2" - 9100TA incluso/included	Ø 15
200KC 015 M 16 12	1/2" x 1/2" - 9200TA incluso/included	16 x 2

230TA S

VALVOLA D'ARREDO A SQUADRA ATTACCO A COMPRESSIONE. FINITURA CROMO.

Angle radiator design valve compression end. Chrome finishing.

Robinet de radiateur décoratif à équerre, connexion à compression. Finition chromée.

230TA S
SINISTRA
Left
Gauche



230TA D

230TA D
DESTRA
Right
Droite



Codice Code	Misura Size Dimensions
230TA 015 S	1/2" x 1/2" sinistra - left - gauche
230TA 015 D	1/2" x 1/2" destra - right - droite

230TA

KIT VALVOLE D'ARREDO A SQUADRA ATTACCO A COMPRESSIONE. FINITURA CROMO.

Kit angle radiator design valves compression end. Chrome finishing.

Set robinets de radiateur décoratif à équerre, connexion à compression. Finition chromée.



Codice Code	Misura Size Dimensions
230TA 015	1/2" x 1/2" Coppia - Pair - Couple

230KCR - 230KCM

KIT VALVOLE D'ARREDO A SQUADRA ATTACCO A COMPRESSIONE. FINITURA CROMO.

Kit angle radiator design valves compression end. Chrome finishing.

Set robinets de radiateur décoratif à équerre, connexion à compression. Finition chromée.



Codice Code	Misura Size Dimensions	Tubo pipe tube
230KC 015 R 12	1/2" x 1/2" - 9100TA incluso/included	Ø 12
230KC 015 R 15	1/2" x 1/2" - 9100TA incluso/included	Ø 15
230KC 015 M 16 12	1/2" x 1/2" - 9200TA incluso/included	16 x 2

130TA S

VALVOLE D'ARREDO A SQUADRA TERMOSTATIZZABILI ATTACCO A COMPRESSIONE. FINITURA CROMO.

Angle thermostatic radiator design valves compression end. Chrome finishing.

Robinets de radiateur décoratif à équerre thermostatizable, connexion à compression. Finition chromée.



SINISTRA
Left
Gauche

Codice	Code	Misura	Size	Dimensions
130TA	015 S	1/2"	x 1/2"	sinistra - left - gauche

130TA D

VALVOLE D'ARREDO A SQUADRA TERMOSTATIZZABILI ATTACCO A COMPRESSIONE. FINITURA CROMO.

Angle thermostatic radiator design valves compression end. Chrome finishing.

Robinets de radiateur décoratif à équerre thermostatizable, connexion à compression. Finition chromée.



DESTRA
Right
Droite

Codice	Code	Misura	Size	Dimensions
130TA	015 D	1/2"	x 1/2"	destra - right - droite

130TA

VALVOLE D'ARREDO A SQUADRA TERMOSTATIZZABILI ATTACCO A COMPRESSIONE. FINITURA CROMO. VALVOLA TERMOSTATIZZABILE A SINISTRA.

Angle thermostatic radiator design valves compression end. Chrome finishing. Thermostatically controlled valve to the left.

Robinets de radiateur décoratif à équerre thermostatizable, connexion à compression. Finition chromée. Commande thermostatique vane à la gauche.



> SINISTRA
Left
Gauche

Codice	Code	Misura	Size	Dimensions
130TA	015	1/2"	x 1/2"	Coppia - Pair - Couple

135TA

VALVOLE D'ARREDO A SQUADRA TERMOSTATIZZABILI ATTACCO A COMPRESSIONE. FINITURA CROMO. VALVOLA TERMOSTATIZZABILE A DESTRA.

Angle thermostatic radiator design valves compression end. Chrome finishing. Thermostatically controlled valve to the right.

Robinets de radiateur décoratif à équerre thermostatizable, connexion à compression. Finition chromée. Commande thermostatique robinet vers la droite.



DESTRA >
Right
Droite

Codice	Code	Misura	Size	Dimensions
135TA	015	1/2"	x 1/2"	Coppia - Pair - Couple

130KCR - 130KCM

KIT VALVOLE D'ARREDO A SQUADRA TERMOSTATIZZABILI ATTACCO A COMPRESSIONE. FINITURA CROMO.

Kit angle thermostatic radiator design valves compression end. Chrome finishing.

Set robinets de radiateur décoratif à équerre thermostatizable, connexion à compression. Finition chromée.



9100TA

9200TA

> SINISTRA
Left
Gauche

Codice	Code	Misura	Size	Dimensions	Tubo pipe tube
130KC	015 R 12	1/2"	x 1/2"	- 9100TA incluso/included	Ø 12
130KC	015 R 15	1/2"	x 1/2"	- 9100TA incluso/included	Ø 15
130KC	015 M 16 12	1/2"	x 1/2"	- 9200TA incluso/included	16 x 2

135KCR - 135KCM

KIT VALVOLE D'ARREDO A SQUADRA TERMOSTATIZZABILI ATTACCO A COMPRESSIONE. FINITURA CROMO.

Kit angle thermostatic radiator design valves compression end. Chrome finishing.

Set robinets de radiateur décoratif à équerre thermostatizable, connexion à compression. Finition chromée.



9100TA

9200TA

DESTRA >
Right
Droite

Codice	Code	Misura	Size	Dimensions	Tubo pipe tube
135KC	015 R 12	1/2"	x 1/2"	- 9100TA incluso/included	Ø 12
135KC	015 R 15	1/2"	x 1/2"	- 9100TA incluso/included	Ø 15
135KC	015 M 16 12	1/2"	x 1/2"	- 9200TA incluso/included	16 x 2

VALVOLE D'ARREDO TONDE FINITURA BIANCA

Round design valves white finishing

Vannes décoratif rond finition blanche

KIT TERMOARREDO.

- ATTUATORE CON SENSORE A LIQUIDO
- VALVOLE IN OTTONE VERNICIATO RAL9016
- CON VITONE TERMOSTATICO O MANUALE
- CAPPUCCIO DI PROTEZIONE IN PLASTICA
- FILETTATURE SECONDO UNI ISO 228/1
- LIMITI DI PRESSIONE 10 BAR (PN 10)
- LIMITI DI TEMPERATURA -20 +110 °C

Radiator kit.

- Liquid sensor actuator
- Valves in brass painted RAL9016
- Valves with thermostatic or manual core
- Plastic protective cap
- Threads according to UNI ISO 228/1
- Pressure limits 10 bar (PN 10)
- Temperature range -20 +110 °C

Kit radiateur.

- Actionneur de capteur de liquide
- Vannes en laiton peint RAL9016
- Vannes à vis thermostatique ou manuelle
- Capuchon de protection en plastique
- Filetages selon UNI ISO 228/1
- Limites de pression 10 bar (PN 10)
- Limites de température -20 +110 °C

2TT BB

TESTA TERMOSTATICA CON SENSORE A LIQUIDO. FINITURA BIANCA.

Thermostatic head with liquid sensor. White finishing.

Tête thermostatique avec capteur de liquide. Finition blanche.



Codice Code	Misura Size Dimensions
2TT BB	M 30 x 1,5

100TB

VALVOLA D'ARREDO A SQUADRA TERMOSTATIZZABILE ATTACCO A COMPRESSIONE. FINITURA BIANCA E CROMO.

Angle thermostatic radiator design valve compression end. White and chrome finishing.

Robinet de radiateur décoratif à équerre thermostatizable, connexion à compression. Finition blanche-chromée.



Codice Code	Misura Size Dimensions
100TB 015	1/2" x 1/2"

100TBK

KIT VALVOLE D'ARREDO A SQUADRA TERMOSTATIZZABILI ATTACCO A COMPRESSIONE. FINITURA BIANCA E CROMO.

Kit angle thermostatic radiator design valves compression end. White and chrome finishing.

Set robinets de radiateur décoratif à équerre thermostatizable, connexion à compression. Finition blanche-chromée.



Codice Code	Misura Size Dimensions
100TBK 015	1/2" x 1/2"

100KBR - 100KBM

KIT VALVOLE D'ARREDO A SQUADRA TERMOSTATIZZABILI ATTACCO A COMPRESSIONE. FINITURA BIANCA E CROMO.

Kit angle thermostatic radiator design valves compression end. White and chrome finishing.

Set robinets de radiateur décoratif à équerre thermostatizable, connexion à compression. Finition blanche-chromée.



Codice Code	Misura Size Dimensions	Tubo pipe tube
100KB 015 R 12	1/2" x 1/2" - 9100TA incluso/included	Ø 12
100KB 015 R 15	1/2" x 1/2" - 9100TA incluso/included	Ø 15
100KB 015 M 16 12	1/2" x 1/2" - 9200TA incluso/included	16 x 2

200TB

VALVOLA D'ARREDO A SQUADRA ATTACCO A COMPRESSIONE. FINITURA BIANCA E CROMO.

Angle radiator design valve compression end. White and chrome finishing.

Robinet de radiateur décoratif à équerre, connexion à compression. Finition blanche-chromée.



Codice Code	Misura Size Dimensions
200TB 015	1/2" x 1/2"

200KB

KIT VALVOLE D'ARREDO A SQUADRA ATTACCO A COMPRESSIONE. FINITURA BIANCA E CROMO.

Kit angle radiator design valves compression end. White and chrome finishing.

Set robinets de radiateur décoratif à équerre, connexion à compression. Finition blanche-chromée.



Codice Code	Misura Size Dimensions
200KB 015	1/2" x 1/2" Coppia - Pair - Couple

200KBR - 200KBM

KIT VALVOLE D'ARREDO A SQUADRA ATTACCO A COMPRESSIONE. FINITURA BIANCA E CROMO.

Kit angle radiator design valves compression end. White and chrome finishing.

Set robinets de radiateur décoratif à équerre, connexion à compression. Finition blanche-chromée.



Codice Code	Misura Size Dimensions	Tubo pipe tube
200KB 015 R 12	1/2" x 1/2" - 9100TA incluso/included	Ø 12
200KB 015 R 15	1/2" x 1/2" - 9100TA incluso/included	Ø 15
200KB 015 M 16 12	1/2" x 1/2" - 9200TA incluso/included	16 x 2

230TB S

VALVOLA D'ARREDO A SQUADRA ATTACCO A COMPRESSIONE. FINITURA BIANCA E CROMO.

Angle radiator design valve compression end. White and chrome finishing.

Robinet de radiateur décoratif à équerre, connexion à compression. Finition blanche-chromée.

230TB S
SINISTRA
Left
Gauche



230TB D

230TB D
DESTRA
Right
Droite



Codice Code	Misura Size Dimensions
230TB 015 S	1/2" x 1/2" sinistra - left - gauche
230TB 015 D	1/2" x 1/2" destra - right - droite

230TB

KIT VALVOLE D'ARREDO A SQUADRA ATTACCO A COMPRESSIONE. FINITURA BIANCA E CROMO.

Kit angle radiator design valves compression end. White and chrome finishing.

Set robinets de radiateur décoratif à équerre, connexion à compression. Finition blanche-chromée.



Codice Code	Misura Size Dimensions
230TB 015	1/2" x 1/2" Coppia - Pair - Couple

230KBR - 230KBM

KIT VALVOLE D'ARREDO A SQUADRA ATTACCO A COMPRESSIONE. FINITURA BIANCA E CROMO.

Kit angle radiator design valves compression end. White and chrome finishing.

Set robinets de radiateur décoratif à équerre, connexion à compression. Finition blanche-chromée.



Codice Code	Misura Size Dimensions	Tubo pipe tube
230KB 015 R 12	1/2" x 1/2" - 9100TA incluso/included	Ø 12
230KB 015 R 15	1/2" x 1/2" - 9100TA incluso/included	Ø 15
230KB 015 M 16 12	1/2" x 1/2" - 9200TA incluso/included	16 x 2

130TB S

VALVOLE D'ARREDO A SQUADRA TERMOSTATIZZABILI
ATTACCO A COMPRESSIONE. FINITURA BIANCA E CROMO.

Angle thermostatic radiator design valves compression end.
White and chrome finishing.

Robinets de radiateur décoratif à
équerre thermostatizable,
connexion à compression.
Finition blanche-chromée.



SINISTRA
Left
Gauche

Codice Code	Misura Size Dimensions
130TB 015 S	1/2" x 1/2" sinistra - left - gauche

130TB D

VALVOLE D'ARREDO A SQUADRA TERMOSTATIZZABILI
ATTACCO A COMPRESSIONE. FINITURA BIANCA E CROMO.

Angle thermostatic radiator design valves compression end.
White and chrome finishing.

Robinets de radiateur décoratif à
équerre thermostatizable,
connexion à compression.
Finition blanche-chromée.



DESTRA
Right
Droite

Codice Code	Misura Size Dimensions
130TB 015 D	1/2" x 1/2" destra - right - droite

130TB

VALVOLE D'ARREDO A SQUADRA TERMOSTATIZZABILI
ATTACCO A COMPRESSIONE. FINITURA BIANCA
E CROMO. VALVOLA TERMOSTATIZZABILE A SINISTRA.



Angle thermostatic radiator design valves compression end.
White and chrome finishing. Thermostatically controlled valve to the left.

Robinets de radiateur décoratif à
équerre thermostatizable,
connexion à compression.
Finition blanche-chromée.
Commande thermostatique
vanne à la gauche.



> SINISTRA
Left
Gauche

Codice Code	Misura Size Dimensions
130TB 015	1/2" x 1/2" Coppia - Pair - Couple

135TB

VALVOLE D'ARREDO A SQUADRA TERMOSTATIZZABILI
ATTACCO A COMPRESSIONE. FINITURA BIANCA E
CROMO. VALVOLA TERMOSTATIZZABILE A DESTRA.



Angle thermostatic radiator design valves compression end.
White and chrome finishing. Thermostatically controlled valve to the right.

Robinets de radiateur décoratif à
équerre thermostatizable,
connexion à compression.
Finition blanche-chromée.
Commande thermostatique
robinet vers la droite.



DESTRA >
Right
Droite

Codice Code	Misura Size Dimensions
135TB 015	1/2" x 1/2" Coppia - Pair - Couple

130KBR - 130KBM

KIT VALVOLE D'ARREDO A SQUADRA
TERMOSTATIZZABILI ATTACCO A
COMPRESSIONE. FINITURA BIANCA E CROMO.

Kit angle thermostatic radiator design valves
compression end. White and chrome finishing.

Set robinets de radiateur décoratif à équerre
thermostatizable, connexion à compression.
Finition blanche-chromée.



9100TA



9200TA



> SINISTRA
Left
Gauche

Codice Code	Misura Size Dimensions	Tubo pipe tube
130KB 015 R 12	1/2" x 1/2" - 9100TA incluso/included	Ø 12
130KB 015 R 15	1/2" x 1/2" - 9100TA incluso/included	Ø 15
130KB 015 M 16 12	1/2" x 1/2" - 9200TA incluso/included	16 x 2

135KBR - 135KBM

KIT VALVOLE D'ARREDO A SQUADRA
TERMOSTATIZZABILI ATTACCO A
COMPRESSIONE. FINITURA BIANCA E CROMO.

Kit angle thermostatic radiator design valves
compression end. White and chrome finishing.

Set robinets de radiateur décoratif à équerre
thermostatizable, connexion à compression.
Finition blanche-chromée.



9100TA



9200TA



DESTRA >
Right
Droite

Codice Code	Misura Size Dimensions	Tubo pipe tube
135KB 015 R 12	1/2" x 1/2" - 9100TA incluso/included	Ø 12
135KB 015 R 15	1/2" x 1/2" - 9100TA incluso/included	Ø 15
135KB 015 M 16 12	1/2" x 1/2" - 9200TA incluso/included	16 x 2

VALVOLE D'ARREDO **TONDE** FINITURA NERA

Round design valves **black finishing**

Vannes décoratif **rond finition noire**

KIT TERMOARREDO.

- ATTUATORE CON SENSORE A LIQUIDO
- VALVOLE IN OTTONE VERNICIATO RAL9004
- CON VITONE TERMOSTATICO O MANUALE
- CAPPUCCHIO DI PROTEZIONE IN PLASTICA
- FILETTATURE SECONDO UNI ISO 228/1
- LIMITI DI PRESSIONE 10 BAR (PN 10)
- LIMITI DI TEMPERATURA -20 +110 °C

Radiator kit.

- Liquid sensor actuator
- Valves in brass painted RAL9004
- Valves with thermostatic or manual core
- Plastic protective cap
- Threads according to UNI ISO 228/1
- Pressure limits 10 bar (PN 10)
- Temperature range -20 +110 °C

Kit radiateur.

- Actionneur de capteur de liquide
- Vannes en laiton peint RAL9004
- Vannes à vis thermostatique ou manuelle
- Capuchon de protection en plastique
- Filetages selon UNI ISO 228/1
- Limites de pression 10 bar (PN 10)
- Limites de température -20 +110 °C

2TT NN

TESTA TERMOSTATICA CON SENSORE A LIQUIDO. FINITURA NERA.

Thermostatic head with liquid sensor. Black finishing.

Tête thermostatique avec capteur de liquide. Finition noire.



Codice Code	Misura Size Dimensions
2TT NN	M 30 x 1,5

100NN

VALVOLA D'ARREDO A SQUADRA TERMOSTATIZZABILE ATTACCO A COMPRESSIONE. FINITURA NERA.

Angle thermostatic radiator design valve compression end. Black finishing.

Robinet de radiateur décoratif à équerre thermostatisable, connexion à compression. Finition noire.



Codice Code	Misura Size Dimensions
100NN 015	1/2" x 1/2"

100NNK

KIT VALVOLE D'ARREDO A SQUADRA TERMOSTATIZZABILI ATTACCO A COMPRESSIONE. FINITURA NERA.

Kit angle thermostatic radiator design valves compression end. Black finishing.

Set robinets de radiateur décoratif à équerre thermostatisable, connexion à compression. Finition noire.



Codice Code	Misura Size Dimensions
100NNK 015	1/2" x 1/2"

100KNNR - 100KNNM

KIT VALVOLE D'ARREDO A SQUADRA TERMOSTATIZZABILI ATTACCO A COMPRESSIONE. FINITURA NERA.

Kit angle thermostatic radiator design valves compression end. Black finishing.

Set robinets de radiateur décoratif à équerre thermostatisable, connexion à compression. Finition noire.



Codice Code	Misura Size Dimensions	Tubo pipe tube
100KNN 015 R 12	1/2" x 1/2" - 9100NN incluso/included	Ø 12
100KNN 015 R 15	1/2" x 1/2" - 9100NN incluso/included	Ø 15
100KNN 015 M 16 12	1/2" x 1/2" - 9200NN incluso/included	16 x 2

200NN

VALVOLA D'ARREDO A SQUADRA ATTACCO A COMPRESSIONE. FINITURA NERA.

Angle radiator design valve compression end. Black finishing.

Robinet de radiateur décoratif à équerre, connexion à compression. Finition noire.



Codice Code	Misura Size Dimensions
200NN 015	1/2" x 1/2"

200KNN

KIT VALVOLE D'ARREDO A SQUADRA ATTACCO A COMPRESSIONE. FINITURA NERA.

Kit angle radiator design valves compression end. Black finishing.

Set robinets de radiateur décoratif à équerre, connexion à compression. Finition noire.



Codice Code	Misura Size Dimensions
200KNN 015	1/2" x 1/2" Coppia - Pair - Couple

200KNNR - 200KNNM

KIT VALVOLE D'ARREDO A SQUADRA ATTACCO A COMPRESSIONE. FINITURA NERA.

Kit angle radiator design valves compression end. Black finishing.

Set robinets de radiateur décoratif à équerre, connexion à compression. Finition noire.



Codice Code	Misura Size Dimensions	Tubo pipe tube
200KNN 015 R 12	1/2" x 1/2" - 9100NN incluso/included	Ø 12
200KNN 015 R 15	1/2" x 1/2" - 9100NN incluso/included	Ø 15
200KNN 015 M 16 12	1/2" x 1/2" - 9200NN incluso/included	16 x 2

230NN S

VALVOLA D'ARREDO A SQUADRA ATTACCO A COMPRESSIONE. FINITURA NERA.

Angle radiator design valve compression end. Black finishing.

Robinet de radiateur décoratif à équerre, connexion à compression. Finition noire.

230NN S
SINISTRA
Left
Gauche



230NN D

230NN D
DESTRA
Right
Droite



Codice Code	Misura Size Dimensions
230NN 015 S	1/2" x 1/2" sinistra - left - gauche
230NN 015 D	1/2" x 1/2" destra - right - droite

230NN

KIT VALVOLE D'ARREDO A SQUADRA ATTACCO A COMPRESSIONE. FINITURA NERA.

Kit angle radiator design valves compression end. Black finishing.

Set robinets de radiateur décoratif à équerre, connexion à compression. Finition noire.



Codice Code	Misura Size Dimensions
230NN 015	1/2" x 1/2" Coppia - Pair - Couple

230KNNR - 230KNNM

KIT VALVOLE D'ARREDO A SQUADRA ATTACCO A COMPRESSIONE. FINITURA NERA.

Kit angle radiator design valves compression end. Black finishing.

Set robinets de radiateur décoratif à équerre, connexion à compression. Finition noire.



Codice Code	Misura Size Dimensions	Tubo pipe tube
230KNN 015 R 12	1/2" x 1/2" - 9100NN incluso/included	Ø 12
230KNN 015 R 15	1/2" x 1/2" - 9100NN incluso/included	Ø 15
230KNN 015 M 16 12	1/2" x 1/2" - 9200NN incluso/included	16 x 2

130NN S

VALVOLE D'ARREDO A SQUADRA TERMOSTATIZZABILI ATTACCO A COMPRESSIONE. FINITURA NERA.

Angle thermostatic radiator design valves compression end. Black finishing.

Robinets de radiateur décoratif à équerre thermostatizable, connexion à compression. Finition noire.



SINISTRA
Left
Gauche

Codice Code	Misura Size Dimensions
130NN 015 S	1/2" x 1/2" sinistra - left - gauche

130NN D

VALVOLE D'ARREDO A SQUADRA TERMOSTATIZZABILI ATTACCO A COMPRESSIONE. FINITURA NERA.

Angle thermostatic radiator design valves compression end. Black finishing.

Robinets de radiateur décoratif à équerre thermostatizable, connexion à compression. Finition noire.



DESTRA
Right
Droite

Codice Code	Misura Size Dimensions
130NN 015 D	1/2" x 1/2" destra - right - droite

130NN

VALVOLE D'ARREDO A SQUADRA TERMOSTATIZZABILI ATTACCO A COMPRESSIONE. FINITURA NERA. VALVOLA TERMOSTATIZZABILE A SINISTRA.

Angle thermostatic radiator design valves compression end. Black finishing. Thermostatically controlled valve to the left.

Robinets de radiateur décoratif à équerre thermostatizable, connexion à compression. Finition noire. Commande thermostatique vanne à la gauche.



> SINISTRA
Left
Gauche

Codice Code	Misura Size Dimensions
130NN 015	1/2" x 1/2" Coppia - Pair - Couple

135NN

VALVOLE D'ARREDO A SQUADRA TERMOSTATIZZABILI ATTACCO A COMPRESSIONE. FINITURA NERA. VALVOLA TERMOSTATIZZABILE A DESTRA.

Angle thermostatic radiator design valves compression end. Black finishing. Thermostatically controlled valve to the right.

Robinets de radiateur décoratif à équerre thermostatizable, connexion à compression. Finition noire. Commande thermostatique vanne à la droite.



DESTRA >
Right
Droite

Codice Code	Misura Size Dimensions
135NN 015	1/2" x 1/2" Coppia - Pair - Couple

130KNNR - 130KNNM

KIT VALVOLE D'ARREDO A SQUADRA TERMOSTATIZZABILI ATTACCO A COMPRESSIONE. FINITURA NERA.

Kit angle thermostatic radiator design valves compression end. Black finishing.

Set robinets de radiateur décoratif à équerre thermostatizable, connexion à compression. Finition noire.



> SINISTRA
Left
Gauche

Codice Code	Misura Size Dimensions	Tubo pipe tube
130KNN 015 R 12	1/2" x 1/2" - 9100NN incluso/included	Ø 12
130KNN 015 R 15	1/2" x 1/2" - 9100NN incluso/included	Ø 15
130KNN 015 M 16 12	1/2" x 1/2" - 9200NN incluso/included	16 x 2

135KNNR - 135KNNM

KIT VALVOLE D'ARREDO A SQUADRA TERMOSTATIZZABILI ATTACCO A COMPRESSIONE. FINITURA NERA.

Kit angle thermostatic radiator design valves compression end. Black finishing.

Set robinets de radiateur décoratif à équerre thermostatizable, connexion à compression. Finition noire.



DESTRA >
Right
Droite

Codice Code	Misura Size Dimensions	Tubo pipe tube
135KNN 015 R 12	1/2" x 1/2" - 9100NN incluso/included	Ø 12
135KNN 015 R 15	1/2" x 1/2" - 9100NN incluso/included	Ø 15
135KNN 015 M 16 12	1/2" x 1/2" - 9200NN incluso/included	16 x 2

VALVOLE D'ARREDO TONDE FINITURA CROMO

Round design valves chrome finishing

Vannes décoratif rond finition chromée

KIT TERMOARREDO.

- ATTUATORE CON SENSORE A LIQUIDO
- VALVOLE IN OTTONE CROMATO
- CON VITONE TERMOSTATICO O MANUALE
- CAPPUCCIO DI PROTEZIONE IN PLASTICA
- FILETTATURE SECONDO UNI ISO 228/1
- ATTACCO A COMPRESSIONE 3/4" EK
- LIMITI DI PRESSIONE 10 BAR (PN 10)
- LIMITI DI TEMPERATURA -20 +110 °C

Radiator kit.

- Liquid sensor actuator
- Valves in chromed brass
- Valves with thermostatic or manual core
- Plastic protective cap
- Threads according to UNI ISO 228/1
- Compression fitting 3/4" EK
- Pressure limits 10 bar (PN 10)
- Temperature range -20 +110 °C

Kit radiateur.

- Actionneur de capteur de liquide
- Vannes en laiton chromé
- Vannes à vis thermostatique ou manuelle
- Capuchon de protection en plastique
- Filetages selon UNI ISO 228/1
- Raccord à compression 3/4" EK
- Limites de pression 10 bar (PN 10)
- Limites de température -20 +110 °C

2TT CC

TESTA TERMOSTATICA CON SENSORE A LIQUIDO.

Thermostatic head with liquid sensor.

Tête thermostatique avec capteur de liquide.



106TA

VALVOLA D'ARREDO A SQUADRA TERMOSTATIZZABILE ATTACCO A COMPRESSIONE. FINITURA CROMO.

Angle thermostatic radiator design valve compression end. Chrome finishing.

Robinet de radiateur décoratif à équerre thermostatizable, connexion à compression. Finition chromée.

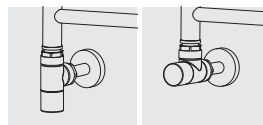

INSTALLAZIONE REVERSIBILE
Reversible installation
Installation réversible



Codice Code	Misura Size	Dimensions
2TT CC	M 30 x 1,5	

Codice Code	Misura Size	Dimensions		
106TA 015	1/2" x 3/4" EK		20	80

206TA

VALVOLA D'ARREDO A SQUADRA ATTACCO A COMPRESSIONE. FINITURA CROMO.

Angle radiator design valve compression end. Chrome finishing.

Robinet de radiateur décoratif à équerre, connexion à compression. Finition chromée.

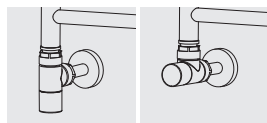

INSTALLAZIONE REVERSIBILE
Reversible installation
Installation réversible



306TA

DETTENORE D'ARREDO A SQUADRA ATTACCO A COMPRESSIONE. FINITURA CROMO.

Angle radiator design lockshield compression end. Chrome finishing.

Détendeur de radiateur décoratif à équerre, connexion à compression. Finition chromée.

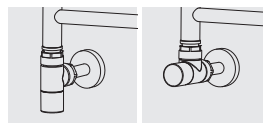

INSTALLAZIONE REVERSIBILE
Reversible installation
Installation réversible



Codice Code	Misura Size	Dimensions		
206TA 015	1/2" x 3/4" EK		20	80

Codice Code	Misura Size	Dimensions		
306TA 015	1/2" x 3/4" EK		20	80

106TAK

KIT VALVOLE D'ARREDO A SQUADRA TERMOSTATIZZABILI ATTACCO A COMPRESIONE. FINITURA CROMO.

Kit angle thermostatic radiator design valves compression end. Chrome finishing.

Set robinets de radiateur décoratif à équerre thermostatisable, connexion à compression. Finition chromée.



Codice	Code	Misura	Size	Dimensions	
106TAK	015	1/2" x 3/4" EK	Coppia - Pair - Couple		

106KCR - 106KCM

KIT VALVOLE D'ARREDO A SQUADRA TERMOSTATIZZABILI ATTACCO A COMPRESIONE. FINITURA CROMO.

Kit angle thermostatic radiator design valves compression end. Chrome finishing.

Set robinets de radiateur décoratif à équerre thermostatisable, connexion à compression. Finition chromée.

**9100TA****9200TA**

Codice	Code	Misura	Size	Dimensions	Tube pipe tube
106KC	015 R	12	1/2"x3/4"	- 9100TA incluso/included	Ø 12
106KC	015 R	14	1/2"x3/4"	- 9100TA incluso/included	Ø 14
106KC	015 R	15	1/2"x3/4"	- 9100TA incluso/included	Ø 15
106KC	015 M	16 12	1/2"x3/4"	- 9200TA incluso/included	16 x 2

206KC

KIT VALVOLE D'ARREDO A SQUADRA ATTACCO A COMPRESIONE. FINITURA CROMO.

Kit angle radiator design valves compression end. Chrome finishing.

Set robinets de radiateur décoratif à équerre, connexion à compression. Finition chromée.



Codice	Code	Misura	Size	Dimensions	
206KC	015	1/2" x 3/4" EK	Coppia - Pair - Couple		

206KCR - 206KCM

KIT VALVOLE D'ARREDO A SQUADRA ATTACCO A COMPRESIONE. FINITURA CROMO.

Kit angle radiator design valves compression end. Chrome finishing.

Set robinets de radiateur décoratif à équerre, connexion à compression. Finition chromée.

**9100TA****9200TA**

Codice	Code	Misura	Size	Dimensions	Tube pipe tube
206KC	015 R	12	1/2"x3/4"	- 9100TA incluso/included	Ø 12
206KC	015 R	14	1/2"x3/4"	- 9100TA incluso/included	Ø 14
206KC	015 R	15	1/2"x3/4"	- 9100TA incluso/included	Ø 15
206KC	015 M	16 12	1/2"x3/4"	- 9200TA incluso/included	16 x 2

VALVOLE D'ARREDO TONDE FINITURA BIANCA

Round design valves white finishing

Vannes décoratif rond finition blanche

KIT TERMOARREDO.

- ATTUATORE CON SENSORE A LIQUIDO
- VALVOLE IN OTTONE VERNICIATO RAL9016
- CON VITONE TERMOSTATICO O MANUALE
- CAPPUCCIO DI PROTEZIONE IN PLASTICA
- FILETTATURE SECONDO UNI ISO 228/1
- ATTACCO A COMPRESSIONE 3/4" EK
- LIMITI DI PRESSIONE 10 BAR (PN 10)
- LIMITI DI TEMPERATURA -20 +110 °C

Radiator kit.

- Liquid sensor actuator
- Valves in brass painted RAL9016
- Valves with thermostatic or manual core
- Plastic protective cap
- Threads according to UNI ISO 228/1
- Compression fitting 3/4" EK
- Pressure limits 10 bar (PN 10)
- Temperature range -20 +110 °C

Kit radiateur.

- Actionneur de capteur de liquide
- Vannes en laiton peint RAL9016
- Vannes à vis thermostatique ou manuelle
- Capuchon de protection en plastique
- Filetages selon UNI ISO 228/1
- Raccord à compression 3/4" EK
- Limites de pression 10 bar (PN 10)
- Limites de température -20 +110 °C

2TT BB

TESTA TERMOSTATICA CON SENSORE A LIQUIDO. FINITURA BIANCA.

Thermostatic head with liquid sensor. White finishing.

Tête thermostatique avec capteur de liquide. Finition blanche.



Codice Code	Misura Size	Dimensions
2TT BB	M 30 x 1,5	

106TB

VALVOLA D'ARREDO A SQUADRA TERMOSTATIZZABILE ATTACCO A COMPRESSIONE. FINITURA BIANCA.

Angle thermostatic radiator design valve compression end. White finishing.

Robinet de radiateur décoratif à équerre thermostatizable, connexion à compression. Finition blanche.

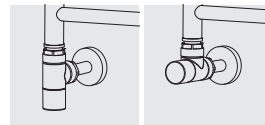

INSTALLAZIONE REVERSIBILE
Reversible installation
Installation réversible



Codice Code	Misura Size	Dimensions	Box	Carton
106TB 015	1/2" x 3/4" EK		20	80

206TB

VALVOLA D'ARREDO A SQUADRA ATTACCO A COMPRESSIONE. FINITURA BIANCA.

Angle radiator design valve compression end. White finishing.

Robinet de radiateur décoratif à équerre, connexion à compression. Finition blanche.

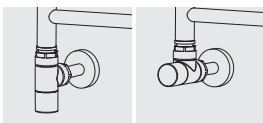

INSTALLAZIONE REVERSIBILE
Reversible installation
Installation réversible



Codice Code	Misura Size	Dimensions	Box	Carton
206TB 015	1/2" x 3/4" EK		20	80

306TB

DETTENORE D'ARREDO A SQUADRA ATTACCO A COMPRESSIONE. FINITURA BIANCA.

Angle radiator design lockshield compression end. White finishing.

Détendeur de radiateur décoratif à équerre, connexion à compression. Finition blanche.

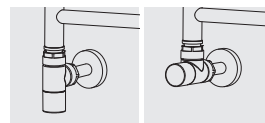

INSTALLAZIONE REVERSIBILE
Reversible installation
Installation réversible



Codice Code	Misura Size	Dimensions	Box	Carton
306TB 015	1/2" x 3/4" EK		20	80

106TBK

KIT VALVOLE D'ARREDO A SQUADRA
TERMOSTATIZZABILI ATTACCO A
COMPRESSIONE. FINITURA
BIANCA.

*Kit angle thermostatic radiator
design valves compression end.
White finishing.*

*Set robinets de radiateur décoratif
à équerre thermostatisable,
connexion à compression.
Finition blanche.*



Codice Code	Misura Size Dimensions
106TBK 015	1/2" x 3/4" EK Coppia - Pair - Couple

106KBR - 106KBM

KIT VALVOLE D'ARREDO A SQUADRA
TERMOSTATIZZABILI ATTACCO A
COMPRESSIONE. FINITURA
BIANCA.

*Kit angle thermostatic radiator design valves
compression end. White finishing.*

*Set robinets de radiateur décoratif
à équerre thermostatisable,
connexion à compression. Finition blanche.*

9100BB**9200BB**

Codice Code	Misura Size Dimensions	Tubo pipe tube
106KB 015 R 12	1/2"x3/4" - 9100BB incluso/included	Ø 12
106KB 015 R 14	1/2"x3/4" - 9100BB incluso/included	Ø 14
106KB 015 R 15	1/2"x3/4" - 9100BB incluso/included	Ø 15
106KB 015 M 16 12	1/2"x3/4" - 9200BB incluso/included	16 x 2

206KB

KIT VALVOLE D'ARREDO A SQUADRA ATTACCO
A COMPRESSIONE. FINITURA
BIANCA.

*Kit angle radiator design valves
compression end. White finishing.*

*Set robinets de radiateur décoratif
à équerre, connexion à compression.
Finition blanche.*



Codice Code	Misura Size Dimensions
206KB 015	1/2" x 3/4" EK Coppia - Pair - Couple

206KBR - 206KBM

KIT VALVOLE D'ARREDO A SQUADRA ATTACCO
A COMPRESSIONE. FINITURA
BIANCA.

*Kit angle radiator design valves
compression end. White finishing.*

*Set robinets de radiateur décoratif
à équerre, connexion à compression.
Finition blanche.*

9100BB**9200BB**

Codice Code	Misura Size Dimensions	Tubo pipe tube
206KB 015 R 12	1/2"x3/4" - 9100BB incluso/included	Ø 12
206KB 015 R 14	1/2"x3/4" - 9100BB incluso/included	Ø 14
206KB 015 R 15	1/2"x3/4" - 9100BB incluso/included	Ø 15
206KB 015 M 16 12	1/2"x3/4" - 9200BB incluso/included	16 x 2

VALVOLE D'ARREDO TONDE FINITURA NERA

Round design valves black finishing

Vannes décoratif rond finition noire

KIT TERMOARREDO.

- ATTUATORE CON SENSORE A LIQUIDO
- VALVOLE IN OTTONE VERNICIATO RAL9004
- CON VITONE TERMOSTATICO O MANUALE
- CAPPUCCHIO DI PROTEZIONE IN PLASTICA
- FILETTATURE SECONDO UNI ISO 228/1
- ATTACCO A COMPRESSIONE 3/4" EK
- LIMITI DI PRESSIONE 10 BAR (PN 10)
- LIMITI DI TEMPERATURA -20 +110 °C

Radiator kit.

- Liquid sensor actuator
- Valves in brass painted RAL9004
- Valves with thermostatic or manual core
- Plastic protective cap
- Threads according to UNI ISO 228/1
- Compression fitting 3/4" EK
- Pressure limits 10 bar (PN 10)
- Temperature range -20 +110 °C

Kit radiateur.

- Actionneur de capteur de liquide
- Vannes en laiton peint RAL9004
- Vannes à vis thermostatique ou manuelle
- Capuchon de protection en plastique
- Filetages selon UNI ISO 228/1
- Raccord à compression 3/4" EK
- Limites de pression 10 bar (PN 10)
- Limites de température -20 +110 °C

2TT NN

TESTA TERMOSTATICA CON SENSORE A LIQUIDO. FINITURA NERA.

Thermostatic head with liquid sensor. Black finishing.

Tête thermostatique avec capteur de liquide. Finition noire.



Codice Code	Misura Size	Dimensions
2TT NN		M 30 x 1,5

106NN

VALVOLA D'ARREDO A SQUADRA TERMOSTATIZZABILE ATTACCO A COMPRESSIONE. FINITURA NERA.

Angle thermostatic radiator design valve compression end. Black finishing.

Robinet de radiateur décoratif à équerre thermostatizable, connexion à compression. Finition noire.

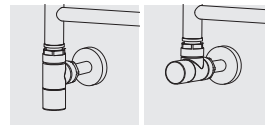

INSTALLAZIONE REVERSIBILE
Reversible installation
Installation réversible



Codice Code	Misura Size	Dimensions	📦	📦
106NN 015		1/2" x 3/4" EK	20	80

206NN

VALVOLA D'ARREDO A SQUADRA ATTACCO A COMPRESSIONE. FINITURA NERA.

Angle radiator design valve compression end. Black finishing.

Robinet de radiateur décoratif à équerre, connexion à compression. Finition noire.

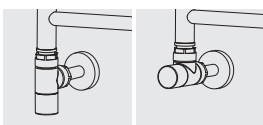

INSTALLAZIONE REVERSIBILE
Reversible installation
Installation réversible



Codice Code	Misura Size	Dimensions	📦	📦
206NN 015		1/2" x 3/4" EK	20	80

306NN

DETTENORE D'ARREDO A SQUADRA ATTACCO A COMPRESSIONE. FINITURA NERA.

Angle radiator design lockshield compression end. Black finishing.

Détendeur de radiateur décoratif à équerre, connexion à compression. Finition noire.

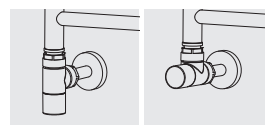

INSTALLAZIONE REVERSIBILE
Reversible installation
Installation réversible



Codice Code	Misura Size	Dimensions	📦	📦
306NN 015		1/2" x 3/4" EK	20	80

106NNK

KIT VALVOLE D'ARREDO A SQUADRA TERMOSTATIZZABILI ATTACCO A COMPRESSIONE. FINITURA NERA.

Kit angle thermostatic radiator design valves compression end. Black finishing.

Set robinets de radiateur décoratif à équerre thermostatisable, connexion à compression. Finition noire.



Codice Code	Misura Size Dimensions
106NNK 015	1/2" x 3/4" EK Coppia - Pair - Couple

106KNNR - 106KNNM

KIT VALVOLE D'ARREDO A SQUADRA TERMOSTATIZZABILI ATTACCO A COMPRESSIONE. FINITURA NERA.

Kit angle thermostatic radiator design valves compression end. Black finishing.

Set robinets de radiateur décoratif à équerre thermostatisable, connexion à compression. Finition noire.

9100NN**9200NN**

Codice Code	Misura Size Dimensions	Tubo pipe tube
106KNN 015 R 12	1/2"x3/4" - 9100NN incluso/included	Ø 12
106KNN 015 R 14	1/2"x3/4" - 9100NN incluso/included	Ø 14
106KNN 015 R 15	1/2"x3/4" - 9100NN incluso/included	Ø 15
106KNN 015 M 16 12	1/2"x3/4" - 9200NN incluso/included	16 x 2

206KNN

KIT VALVOLE D'ARREDO A SQUADRA ATTACCO A COMPRESSIONE. FINITURA NERA.

Kit angle radiator design valves compression end. Black finishing.

Set robinets de radiateur décoratif à équerre, connexion à compression. Finition noire.



Codice Code	Misura Size Dimensions
206KNN 015	1/2" x 3/4" EK Coppia - Pair - Couple

206KNNR - 206KNNM

KIT VALVOLE D'ARREDO A SQUADRA ATTACCO A COMPRESSIONE. FINITURA NERA.

Kit angle radiator design valves compression end. Black finishing.

Set robinets de radiateur décoratif à équerre, connexion à compression. Finition noire.

9100NN**9200NN**

Codice Code	Misura Size Dimensions	Tubo pipe tube
206KNN 015 R 12	1/2"x3/4" - 9100NN incluso/included	Ø 12
206KNN 015 R 14	1/2"x3/4" - 9100NN incluso/included	Ø 14
206KNN 015 R 15	1/2"x3/4" - 9100NN incluso/included	Ø 15
206KNN 015 M 16 12	1/2"x3/4" - 9200NN incluso/included	16 x 2

VALVOLE D'ARREDO **QUADRE**

Square design valves

*Vannes décoratif **carrée***

FINITURA CROMO

Chrome finishing Finition chromée

FINITURA BIANCA

White finishing Finition blanche

FINITURA NERA

Black finishing Finition noire

VALVOLE D'ARREDO **QUADRE** FINITURA CROMO

Square design valves **chrome finishing**

Vannes décoratif **carrée finition chromée**

KIT TERMOARREDO.

- ATTUATORE CON SENSORE A LIQUIDO
- VALVOLE IN OTTONE CROMATO
- CON VITONE TERMOSTATICO O MANUALE
- CAPPUCCIO DI PROTEZIONE IN PLASTICA
- FILETTATURE SECONDO UNI ISO 228/1
- ATTACCO A COMPRESSIONE 3/4" EK
- LIMITI DI PRESSIONE 10 BAR (PN 10)
- LIMITI DI TEMPERATURA -20 +110 °C

Radiator kit.

- Liquid sensor actuator
- Valves in chromed brass
- Valves with thermostatic or manual core
- Plastic protective cap
- Threads according to UNI ISO 228/1
- Compression fitting 3/4" EK
- Pressure limits 10 bar (PN 10)
- Temperature range -20 +110 °C

Kit radiateur.

- Actionneur de capteur de liquide
- Vannes en laiton chromé
- Vannes à vis thermostatique ou manuelle
- Capuchon de protection en plastique
- Filetages selon UNI ISO 228/1
- Raccord à compression 3/4" EK
- Limites de pression 10 bar (PN 10)
- Limites de température -20 +110 °C

2TT CC

TESTA TERMOSTATICA CON SENSORE A LIQUIDO.

Thermostatic head with liquid sensor.

Tête thermostatique avec capteur de liquide.



Codice Code | Misura Size Dimensions

2TT CC | M 30 x 1,5

107TA

VALVOLA D'ARREDO A SQUADRA TERMOSTATIZZABILE
ATTACCO A COMPRESSIONE. FINITURA CROMO.

Angle thermostatic radiator design valve
compression end. Chrome finishing.

Robinet de radiateur décoratif à équerre
thermostatizable, connexion à compression.
Finition chromée.

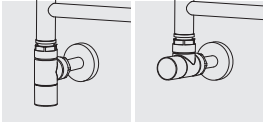

INSTALLAZIONE REVERSIBILE
Reversible installation
Installation réversible



Codice Code	Misura Size Dimensions
107TA 015	1/2" x 3/4" EK

207TA

VALVOLA D'ARREDO A SQUADRA ATTACCO
A COMPRESSIONE. FINITURA CROMO.

Angle radiator design valve compression
end. Chrome finishing.

Robinet de radiateur décoratif à équerre,
connexion à compression.
Finition chromée.

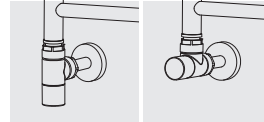

INSTALLAZIONE REVERSIBILE
Reversible installation
Installation réversible



Codice Code	Misura Size Dimensions
207TA 015	1/2" x 3/4" EK

107TAK

KIT VALVOLE D'ARREDO A SQUADRA
TERMOSTATIZZABILI ATTACCO
A COMPRESSIONE. FINITURA CROMO.

Kit angle thermostatic radiator design
valves compression end. Chrome finishing.

Set robinets de radiateur décoratif à
équerre thermostatizable, connexion à
compression. Finition chromée.



Codice Code	Misura Size Dimensions
107TAK 015	1/2" x 3/4" EK Coppia - Pair - Couple

207KC

KIT VALVOLE D'ARREDO A SQUADRA
ATTACCO A COMPRESSIONE.
FINITURA CROMO.

Kit angle radiator design valves compres-
sion end. Chrome finishing.

Set robinets de radiateur décoratif à
équerre, connexion à compression.
Finition chromée.



Codice Code	Misura Size Dimensions
207KC 015	1/2" x 3/4" EK Coppia - Pair - Couple

107KCR - 107KCM

KIT VALVOLE D'ARREDO A SQUADRA
TERMOSTATIZZABILI ATTACCO
A COMPRESSIONE. FINITURA CROMO.

Kit angle thermostatic radiator design
valves compression end. Chrome finishing.

Set robinets de radiateur décoratif à
équerre thermostatizable, connexion à
compression. Finition chromée.



9100TA

9200TA



Codice Code	Misura Size Dimensions	Tubo pipe tube
107KC 015 R 12	1/2" x 3/4" - 9100TA incluso/included	Ø 12
107KC 015 R 14	1/2" x 3/4" - 9100TA incluso/included	Ø 14
107KC 015 R 15	1/2" x 3/4" - 9100TA incluso/included	Ø 15
107KC 015 M 16 12	1/2" x 3/4" - 9200TA incluso/included	16 x 2

207KCR - 207KCM

KIT VALVOLE D'ARREDO A SQUADRA
ATTACCO A COMPRESSIONE.
FINITURA CROMO.

Kit angle radiator design valves compres-
sion end. Chrome finishing.

Set robinets de radiateur décoratif à
équerre, connexion à compression.
Finition chromée.



9100TA

9200TA



Codice Code	Misura Size Dimensions	Tubo pipe tube
207KC 015 R 12	1/2" x 3/4" - 9100TA incluso/included	Ø 12
207KC 015 R 14	1/2" x 3/4" - 9100TA incluso/included	Ø 14
207KC 015 R 15	1/2" x 3/4" - 9100TA incluso/included	Ø 15
207KC 015 M 16 12	1/2" x 3/4" - 9200TA incluso/included	16 x 2

137TA

VALVOLE D'ARREDO A SQUADRA TERMOSTATIZZABILI ATTACCO A COMPRESSIONE. FINITURA CROMO.

Angle thermostatic radiator design valves compression end. Chrome finishing.

Robinets de radiateur décoratif à équerre thermostatizable, connexion à compression. Finition chromée.



REVERSIBILE DESTRA E SINISTRA
Reversible left and right
Réversible gauche et droite

Codice Code	Misura Size Dimensions
137TA 015	1/2" x 3/4" EK

237TA

VALVOLA D'ARREDO A SQUADRA ATTACCO A COMPRESSIONE. FINITURA CROMO.

Angle radiator design valve compression end. Chrome finishing.

Robinets de radiateur décoratif à équerre, connexion à compression. Finition chromée.



REVERSIBILE DESTRA E SINISTRA
Reversible left and right
Réversible gauche et droite

Codice Code	Misura Size Dimensions
237TA 015	1/2" x 3/4" EK

137TAK

VALVOLE D'ARREDO A SQUADRA TERMOSTATIZZABILI ATTACCO A COMPRESSIONE. FINITURA CROMO.

Angle thermostatic radiator design valves compression end. Chrome finishing.

Robinets de radiateur décoratif à équerre thermostatizable, connexion à compression. Finition chromée.



Codice Code	Misura Size Dimensions	Coppia - Pair - Couple
137TAK 015	1/2" x 3/4" EK	Coppia - Pair - Couple

237KC

KIT VALVOLE D'ARREDO A SQUADRA ATTACCO A COMPRESSIONE. FINITURA CROMO.

Kit angle radiator design valves compression end. Chrome finishing.

Set robinets de radiateur décoratif à équerre, connexion à compression. Finition chromée.



Codice Code	Misura Size Dimensions	Coppia - Pair - Couple
237KC 015	1/2" x 3/4" EK	Coppia - Pair - Couple

137KCR - 137KCM

KIT VALVOLE D'ARREDO A SQUADRA TERMOSTATIZZABILI ATTACCO A COMPRESSIONE. FINITURA CROMO.

Kit angle thermostatic radiator design valves compression end. Chrome finishing.

Set robinets de radiateur décoratif à équerre thermostatizable, connexion à compression. Finition chromée.



Codice Code	Misura Size Dimensions	Tubo pipe tube
137KC 015 R 12	1/2" x 3/4" - 9100TA incluso/included	Ø 12
137KC 015 R 14	1/2" x 3/4" - 9100TA incluso/included	Ø 14
137KC 015 R 15	1/2" x 3/4" - 9100TA incluso/included	Ø 15
137KC 015 M 16 12	1/2" x 3/4" - 9200TA incluso/included	16 x 2

237KCR - 237KCM

KIT VALVOLE D'ARREDO A SQUADRA ATTACCO A COMPRESSIONE. FINITURA CROMO.

Kit angle radiator design valves compression end. Chrome finishing.

Set robinets de radiateur décoratif à équerre, connexion à compression. Finition chromée.



Codice Code	Misura Size Dimensions	Tubo pipe tube
237KC 015 R 12	1/2" x 3/4" - 9100TA incluso/included	Ø 12
237KC 015 R 14	1/2" x 3/4" - 9100TA incluso/included	Ø 14
237KC 015 R 15	1/2" x 3/4" - 9100TA incluso/included	Ø 15
237KC 015 M 16 12	1/2" x 3/4" - 9200TA incluso/included	16 x 2

VALVOLE D'ARREDO **QUADRE** FINITURA BIANCA

Square design valves white finishing

Vannes décoratif carrée finition blanche

KIT TERMOARREDO.

- ATTUATORE CON SENSORE A LIQUIDO
- VALVOLE IN OTTONE VERNICIATO RAL9016
- CON VITONE TERMOSTATICO O MANUALE
- CAPPUCCIO DI PROTEZIONE IN PLASTICA
- FILETTATURE SECONDO UNI ISO 228/1
- ATTACCO A COMPRESSIONE 3/4" EK
- LIMITI DI PRESSIONE 10 BAR (PN 10)
- LIMITI DI TEMPERATURA -20 +110 °C

Radiator kit.

- Liquid sensor actuator
- Valves in brass painted RAL9016
- Valves with thermostatic or manual core
- Plastic protective cap
- Threads according to UNI ISO 228/1
- Compression fitting 3/4" EK
- Pressure limits 10 bar (PN 10)
- Temperature range -20 +110 °C

Kit radiateur.

- Actionneur de capteur de liquide
- Vannes en laiton peint RAL9016
- Vannes à vis thermostatique ou manuelle
- Capuchon de protection en plastique
- Filetages selon UNI ISO 228/1
- Raccord à compression 3/4" EK
- Limites de pression 10 bar (PN 10)
- Limites de température -20 +110 °C

2TT BB

TESTA TERMOSTATICA CON SENSORE A LIQUIDO. FINITURA BIANCA.

Thermostatic head with liquid sensor. White finishing.

Tête thermostatique avec capteur de liquide. Finition blanche.



Codice Code	Misura Size	Dimension Dimensions
2TT BB		M 30 x 1,5

107TB

VALVOLA D'ARREDO A SQUADRA TERMOSTATIZZABILE
ATTACCO A COMPRESSIONE. FINITURA BIANCA E CROMO.

*Angle thermostatic radiator design valve
compression end. White and chrome finishing.*

*Robinet de radiateur décoratif à équerre
thermostatizable, connexion à compression.
Finition blanche-chromée.*

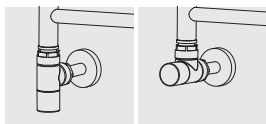

INSTALLAZIONE REVERSIBILE
Reversible installation
Installation réversible



Codice Code	Misura Size Dimensions
107TB 015	1/2" x 3/4" EK

207TB

VALVOLA D'ARREDO A SQUADRA ATTACCO
A COMPRESSIONE. FINITURA BIANCA E CROMO.

*Angle radiator design valve compression end.
White and chrome finishing.*

*Robinet de radiateur décoratif à équerre,
connexion à compression.
Finition blanche-chromée.*

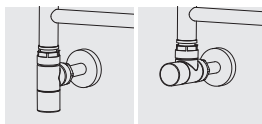

INSTALLAZIONE REVERSIBILE
Reversible installation
Installation réversible



Codice Code	Misura Size Dimensions
207TB 015	1/2" x 3/4" EK

107TBK

KIT VALVOLE D'ARREDO A SQUADRA
TERMOSTATIZZABILI ATTACCO A
COMPRESSIONE.
FINITURA BIANCA E CROMO.

*Kit angle thermostatic radiator
design valves compression end.
White and chrome finishing.*

*Set robinets de radiateur décoratif
à équerre thermostatizable,
connexion à compression.
Finition blanche-chromée.*



Codice Code	Misura Size Dimensions
107TBK 015	1/2" x 3/4" EK Coppia - Pair - Couple

207KB

KIT VALVOLE D'ARREDO A SQUADRA ATTACCO
A COMPRESSIONE.
FINITURA BIANCA E CROMO.

*Kit angle radiator design valves compression
end. White and chrome finishing.*

*Set robinets de radiateur décoratif
à équerre, connexion à compression.
Finition blanche-chromée.*



Codice Code	Misura Size Dimensions
207KB 015	1/2" x 3/4" EK Coppia - Pair - Couple

107KBR - 107KBM

KIT VALVOLE D'ARREDO A SQUADRA TERMOSTA-
TIZZABILI ATTACCO A COMPRESSIONE.
FINITURA BIANCA E CROMO.

*Kit angle thermostatic radiator design valves
compression end. White and chrome finishing.*

*Set robinets de radiateur décoratif à équerre
thermostatizable, connexion à compression.
Finition blanche-chromée.*



Codice Code	Misura Size Dimensions	Tubo pipe tube
107KB 015 R 12	1/2" x 3/4" - 9100TA incluso/included	Ø 12
107KB 015 R 14	1/2" x 3/4" - 9100TA incluso/included	Ø 14
107KB 015 R 15	1/2" x 3/4" - 9100TA incluso/included	Ø 15
107KB 015 M 16 12	1/2" x 3/4" - 9200TA incluso/included	16 x 2

207KBR - 207KBM

KIT VALVOLE D'ARREDO A SQUADRA
ATTACCO A COMPRESSIONE.
FINITURA BIANCA E CROMO.

*Kit angle radiator design valves compres-
sion end. White and chrome finishing.*

*Set robinets de radiateur décoratif à
équerre, connexion à compression.
Finition blanche-chromée.*



Codice Code	Misura Size Dimensions	Tubo pipe tube
207KB 015 R 12	1/2" x 3/4" - 9100TA incluso/included	Ø 12
207KB 015 R 14	1/2" x 3/4" - 9100TA incluso/included	Ø 14
207KB 015 R 15	1/2" x 3/4" - 9100TA incluso/included	Ø 15
207KB 015 M 16 12	1/2" x 3/4" - 9200TA incluso/included	16 x 2

137TB

VALVOLE D'ARREDO A SQUADRA TERMOSTATIZZABILI
ATTACCO A COMPRESSIONE. FINITURA BIANCA E CROMO.

*Angle thermostatic radiator design valves compression end.
White and chrome finishing.*

*Robinets de radiateur décoratif à
équerre thermostatizable,
connexion à compression.
Finition blanche-chromée.*



REVERSIBILE DESTRA E SINISTRA
*Reversible left and right
Réversible gauche et droite*

Codice Code	Misura Size Dimensions
137TB 015	1/2" x 3/4" EK

237TB

VALVOLA D'ARREDO A SQUADRA ATTACCO A COMPRESSIONE.
FINITURA BIANCA E CROMO.

*Angle radiator design valve compression end.
White and chrome finishing.*

*Robinet de radiateur décoratif à équerre,
connexion à compression.
Finition blanche-chromée.*



REVERSIBILE DESTRA E SINISTRA
*Reversible left and right
Réversible gauche et droite*

Codice Code	Misura Size Dimensions
237TB 015	1/2" x 3/4" EK

137TBK

VALVOLE D'ARREDO A SQUADRA
TERMOSTATIZZABILI ATTACCO A COMPRESSIONE.
FINITURA BIANCA E CROMO.

*Angle thermostatic radiator design valves compression end.
White and chrome finishing.*

*Robinets de radiateur décoratif à
équerre thermostatizable,
connexion à compression.
Finition blanche-chromée.*



Codice Code	Misura Size Dimensions
137TBK 015	1/2" x 3/4" EK Coppia - Pair - Couple

237KB

KIT VALVOLE D'ARREDO A SQUADRA ATTACCO
A COMPRESSIONE. FINITURA BIANCA E CROMO.

*Kit angle radiator design valves compression
end. White and chrome finishing.*

*Set robinets de radiateur décoratif
à équerre, connexion à compression.
Finition blanche-chromée.*



Codice Code	Misura Size Dimensions
237KB 015	1/2" x 3/4" EK Coppia - Pair - Couple

137KBR - 137KBM

KIT VALVOLE D'ARREDO A SQUADRA TERMOSTA-
TIZZABILI ATTACCO A COMPRESSIONE.
FINITURA BIANCA E CROMO.

*Kit angle thermostatic radiator design valves
compression end. White and chrome finishing.*

*Set robinets de radiateur décoratif à équerre
thermostatizable, connexion à compression.
Finition blanche-chromée.*



Codice Code	Misura Size Dimensions	Tubo pipe tube
137KB 015 R 12	1/2" x 3/4" - 9100TA incluso/included	Ø 12
137KB 015 R 14	1/2" x 3/4" - 9100TA incluso/included	Ø 14
137KB 015 R 15	1/2" x 3/4" - 9100TA incluso/included	Ø 15
137KB 015 M 16 12	1/2" x 3/4" - 9200TA incluso/included	16 x 2

237KBR - 237KBM

KIT VALVOLE D'ARREDO A SQUADRA
ATTACCO A COMPRESSIONE.
FINITURA BIANCA E CROMO.

*Kit angle radiator design valves compres-
sion end. White and chrome finishing.*

*Set robinets de radiateur décoratif à
équerre, connexion à compression.
Finition blanche-chromée.*



Codice Code	Misura Size Dimensions	Tubo pipe tube
237KB 015 R 12	1/2" x 3/4" - 9100TA incluso/included	Ø 12
237KB 015 R 14	1/2" x 3/4" - 9100TA incluso/included	Ø 14
237KB 015 R 15	1/2" x 3/4" - 9100TA incluso/included	Ø 15
237KB 015 M 16 12	1/2" x 3/4" - 9200TA incluso/included	16 x 2

VALVOLE D'ARREDO **QUADRE** FINITURA NERA

Square design valves **black finishing**

Vannes décoratif **carrée finition noire**

KIT TERMOARREDO.

- ATTUATORE CON SENSORE A LIQUIDO
- VALVOLE IN OTTONE VERNICIATO RAL9004
- CON VITONE TERMOSTATICO O MANUALE
- CAPPuccio DI PROTEZIONE IN PLASTICA
- FILETTATURE SECONDO UNI ISO 228/1
- ATTACCO A COMPRESSIONE 3/4" EK
- LIMITI DI PRESSIONE 10 BAR (PN 10)
- LIMITI DI TEMPERATURA -20 +110 °C

Radiator kit.

- Liquid sensor actuator
- Valves in brass painted RAL9004
- Valves with thermostatic or manual core
- Plastic protective cap
- Threads according to UNI ISO 228/1
- Compression fitting 3/4" EK
- Pressure limits 10 bar (PN 10)
- Temperature range -20 +110 °C

Kit radiateur.

- Actionneur de capteur de liquide
- Vannes en laiton peint RAL9004
- Vannes à vis thermostatique ou manuelle
- Capuchon de protection en plastique
- Filetages selon UNI ISO 228/1
- Raccord à compression 3/4" EK
- Limites de pression 10 bar (PN 10)
- Limites de température -20 +110 °C

2TT NN

TESTA TERMOSTATICA CON SENSORE
A LIQUIDO. FINITURA NERA.

*Thermostatic head with liquid sensor.
Black finishing.*

*Tête thermostatique avec capteur de liquide.
Finition noire.*

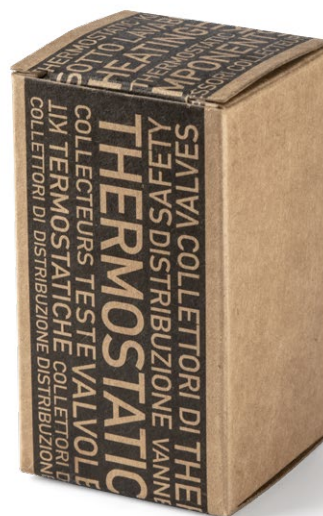

Codice Code	Misura Size	Dimensioni Dimensions
2TT NN		M 30 x 1,5

107NN

VALVOLA D'ARREDO A SQUADRA TERMOSTATIZZABILE
ATTACCO A COMPRESSIONE. FINITURA NERA.

Angle thermostatic radiator design
valve compression end. Black finishing.

Robinet de radiateur décoratif à équerre
thermostatizable, connexion à compression.
Finition noire.

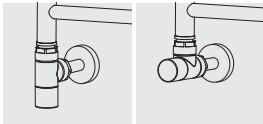

INSTALLAZIONE REVERSIBILE
Reversible installation
Installation réversible



Codice Code	Misura Size Dimensions
107NN 015	1/2" x 3/4" EK

207NN

VALVOLA D'ARREDO A SQUADRA ATTACCO
A COMPRESSIONE. FINITURA NERA.

Angle radiator design valve compression
end. Black finishing.

Robinet de radiateur décoratif à équerre,
connexion à compression.
Finition noire.

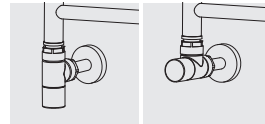

INSTALLAZIONE REVERSIBILE
Reversible installation
Installation réversible



Codice Code	Misura Size Dimensions
207NN 015	1/2" x 3/4" EK

107NNK

KIT VALVOLE D'ARREDO A SQUADRA
TERMOSTATIZZABILI ATTACCO A
COMPRESSIONE. FINITURA NERA.

Kit angle thermostatic radiator
design valves compression end.
Black finishing.

Set robinets de radiateur décoratif
à équerre thermostatizable,
connexion à compression.
Finition noire.



Codice Code	Misura Size Dimensions
107NNK 015	1/2" x 3/4" EK Coppia - Pair - Couple

207KNN

KIT VALVOLE D'ARREDO A SQUADRA ATTACCO
A COMPRESSIONE. FINITURA NERA.

Kit angle radiator design valves
compression end. Black finishing.

Set robinets de radiateur décoratif à
équerre, connexion à compression.
Finition noire.



Codice Code	Misura Size Dimensions
207KNN 015	1/2" x 3/4" EK Coppia - Pair - Couple

107KNNR - 107KNNM

KIT VALVOLE D'ARREDO A SQUADRA
TERMOSTATIZZABILI ATTACCO A
COMPRESSIONE. FINITURA NERA.

Kit angle thermostatic radiator design valves
compression end. Black finishing.

Set robinets de radiateur décoratif à équerre
thermostatizable, connexion à compression.
Finition noire.



Codice Code	Misura Size Dimensions	Tubo pipe tube
107KNN 015 R 12	1/2" x 3/4" - 9100NN incluso/included	Ø 12
107KNN 015 R 14	1/2" x 3/4" - 9100NN incluso/included	Ø 14
107KNN 015 R 15	1/2" x 3/4" - 9100NN incluso/included	Ø 15
107KNN 015 M 16 12	1/2" x 3/4" - 9200NN incluso/included	16 x 2

207KNNR - 207KNNM

KIT VALVOLE D'ARREDO A SQUADRA ATTACCO
A COMPRESSIONE. FINITURA NERA.

Kit angle radiator design valves
compression end. Black finishing.

Set robinets de radiateur décoratif à
équerre, connexion à compression.
Finition noire.



Codice Code	Misura Size Dimensions	Tubo pipe tube
207KNN 015 R 12	1/2" x 3/4" - 9100NN incluso/included	Ø 12
207KNN 015 R 14	1/2" x 3/4" - 9100NN incluso/included	Ø 14
207KNN 015 R 15	1/2" x 3/4" - 9100NN incluso/included	Ø 15
207KNN 015 M 16 12	1/2" x 3/4" - 9200NN incluso/included	16 x 2

137NN

VALVOLE D'ARREDO A SQUADRA TERMOSTATIZZABILI ATTACCO A COMPRESSIONE. FINITURA NERA.

Angle thermostatic radiator design valves compression end. Black finishing.

Robinets de radiateur décoratif à équerre thermostatizable, connexion à compression. Finition noire.



REVERSIBILE DESTRA E SINISTRA
Reversible left and right
Réversible gauche et droite

Codice Code	Misura Size Dimensions
137NN 015	1/2" x 3/4" EK

237NN

VALVOLA D'ARREDO A SQUADRA ATTACCO A COMPRESSIONE. FINITURA NERA.

Angle radiator design valve compression end. Black finishing.

Robinet de radiateur décoratif à équerre, connexion à compression. Finition noire.



REVERSIBILE DESTRA E SINISTRA
Reversible left and right
Réversible gauche et droite

Codice Code	Misura Size Dimensions
237NN 015	1/2" x 3/4" EK

137NNK

VALVOLE D'ARREDO A SQUADRA TERMOSTATIZZABILI ATTACCO A COMPRESSIONE. FINITURA NERA.

Angle thermostatic radiator design valves compression end. Black finishing.

Robinets de radiateur décoratif à équerre thermostatizable, connexion à compression. Finition noire.



Codice Code	Misura Size Dimensions
137NNK 015	1/2" x 3/4" EK Coppia - Pair - Couple

237KNN

KIT VALVOLE D'ARREDO A SQUADRA ATTACCO A COMPRESSIONE. FINITURA NERA.

Kit angle radiator design valves compression end. Black finishing.

Set robinets de radiateur décoratif à équerre, connexion à compression. Finition noire.



Codice Code	Misura Size Dimensions
237KNN 015	1/2" x 3/4" EK Coppia - Pair - Couple

137KNNR - 137KNNM

KIT VALVOLE D'ARREDO A SQUADRA TERMOSTATIZZABILI ATTACCO A COMPRESSIONE. FINITURA NERA.

Kit angle thermostatic radiator design valves compression end. Black finishing.

Set robinets de radiateur décoratif à équerre thermostatizable, connexion à compression. Finition noire.

9100NN 9200NN



Codice Code	Misura Size Dimensions	Tubo pipe tube
137KNN 015 R 12	1/2" x 3/4" - 9100NN incluso/included	Ø 12
137KNN 015 R 14	1/2" x 3/4" - 9100NN incluso/included	Ø 14
137KNN 015 R 15	1/2" x 3/4" - 9100NN incluso/included	Ø 15
137KNN 015 M 16 12	1/2" x 3/4" - 9200NN incluso/included	16 x 2

237KNNR - 237KNNM

KIT VALVOLE D'ARREDO A SQUADRA ATTACCO A COMPRESSIONE. FINITURA NERA.

Kit angle radiator design valves compression end. Black finishing.

Set robinets de radiateur décoratif à équerre, connexion à compression. Finition noire.

9100NN 9200NN



Codice Code	Misura Size Dimensions	Tubo pipe tube
237KNN 015 R 12	1/2" x 3/4" - 9100NN incluso/included	Ø 12
237KNN 015 R 14	1/2" x 3/4" - 9100NN incluso/included	Ø 14
237KNN 015 R 15	1/2" x 3/4" - 9100NN incluso/included	Ø 15
237KNN 015 M 16 12	1/2" x 3/4" - 9200NN incluso/included	16 x 2

ADATTATORI *Adapters Raccords*

9100TA

ADATTATORE A COMPRESSIONE CON TENUTA IN GOMMA PER TUBO RAME.

Adapter for copper pipe.

Raccord à compression avec joint en caoutchouc pour tube cuivre.



Codice Code	Misura Size Dimensions	Per tubo For pipe Pour tube
9100TA 12 015	Ø 12 x 1/2"	Ø 12
9100TA 15 015	Ø 15 x 1/2"	Ø 15
9100TA 12 020	Ø 12 x 3/4"	Ø 12
9100TA 14 020	Ø 14 x 3/4"	Ø 14
9100TA 15 020	Ø 15 x 3/4"	Ø 15

9200TA

ADATTATORE A COMPRESSIONE CON TENUTA O-RING E ANELLO PTFE PER TUBO PEX E MULTISTRATO.

Adapter for PEX/AL-PEX.

Raccord à compression avec O-Ring et anneau PTFE pour tubes PEX et multicouches.



Codice Code	Misura Size Dimensions	Per tubo For pipe Pour tube
9200TA 16 12 015	16/12 x 1/2"	16 x 2
9200TA 16 12 020	16/12 x 3/4"	16 x 2

9100BB

ADATTATORE A COMPRESSIONE CON TENUTA IN GOMMA PER TUBO RAME. FINITURA BIANCA.

Adapter for copper pipe. White finishing.

Raccord à compression avec joint en caoutchouc pour tube cuivre. Finition blanche.



Codice Code	Misura Size Dimensions	Per tubo For pipe Pour tube
9100BB 12 020	Ø 12 x 3/4"	Ø 12
9100BB 14 020	Ø 14 x 3/4"	Ø 14
9100BB 15 020	Ø 15 x 3/4"	Ø 15

9200BB

ADATTATORE A COMPRESSIONE CON TENUTA O-RING E ANELLO PTFE PER TUBO PEX E MULTISTRATO. FINITURA BIANCA.

Adapter for PEX/AL-PEX. White finishing.

Raccord à compression avec O-Ring et anneau PTFE pour tubes PEX et multicouches. Finition blanche.



Codice Code	Misura Size Dimensions	Per tubo For pipe Pour tube
9200BB 16 12 020	16/12 x 3/4"	16 x 2

9100NN

ADATTATORE A COMPRESSIONE CON TENUTA IN GOMMA PER TUBO RAME. FINITURA NERA.

Adapter for copper pipe. Black finishing.

Raccord à compression avec joint en caoutchouc pour tube cuivre. Finition noire.



Codice Code	Misura Size Dimensions	Per tubo For pipe Pour tube
9100NN 12 015	Ø 12 x 1/2"	Ø 12
9100NN 15 015	Ø 15 x 1/2"	Ø 15
9100NN 12 020	Ø 12 x 3/4"	Ø 12
9100NN 14 020	Ø 14 x 3/4"	Ø 14
9100NN 15 020	Ø 15 x 3/4"	Ø 15

9200NN

ADATTATORE A COMPRESSIONE CON TENUTA O-RING E ANELLO PTFE PER TUBO PEX E MULTISTRATO. FINITURA NERA.

Adapter for PEX/AL-PEX. Black finishing.

Raccord à compression avec O-Ring et anneau PTFE pour tubes PEX et multicouches. Finition noire.



Codice Code	Misura Size Dimensions	Per tubo For pipe Pour tube
9200NN 16 12 015	16/12 x 1/2"	16 x 2
9200NN 16 12 020	16/12 x 3/4"	16 x 2

VALVOLE D'ARREDO **MODELLO EXPORT***Design valves* **export type***Vannes décoratif* **modèle export**

VALVOLE TERMOARREDO.

- IN OTTONE CROMATO
- CON VITONE MANUALE
- VOLANTINO E CAPPUCCIO IN PLASTICA
- FILETTATURE SECONDO UNI ISO 228/1
- ATTACCO G1/2" PER RACCORDI A COMPRESSIONE
- LIMITI DI PRESSIONE 10 BAR (PN 10)
- LIMITI DI TEMPERATURA -10 +110 °C

Heating valves.

- Made in chromed brass
- With manual screw
- Plastic handwheel and cap
- Threads according to uni iso 228/1
- G1/2" connection for compression fittings
- Pressure limits 10 bar (PN 10)
- Temperature range -10 +110 °C

Vannes de chauffage.

- Fabriqué en laiton chromé
- Avec vis manuelle
- Volant et capuchon en plastique
- Filetages selon uni iso 228/1
- Raccord G1 / 2 "pour raccords à compression
- Limites de pression 10 bar (PN 10)
- Limites de température -10 +110 °C

250TA

VALVOLA D'ARREDO A SQUADRA ATTACCO A COMPRESSIONE. FINITURA CROMO.

*Angle radiator design valve compression end. Chrome finishing.**Robinet de radiateur décoratif à équerre, connexion à compression. Finition chromée.***350TA**

VALVOLA D'ARREDO A SQUADRA ATTACCO A COMPRESSIONE. FINITURA CROMO.

*Angle radiator design valve compression end. Chrome finishing.**Robinet de radiateur décoratif à équerre, connexion à compression. Finition chromée.*

Codice Code	Misura Size Dimensions
250TA 015	1/2" x 1/2"

Codice Code	Misura Size Dimensions
350TA 015	1/2" x 1/2"

9100TA

ADATTATORE A COMPRESSIONE CON TENUTA IN GOMMA PER TUBO RAME.

*Adapter for copper pipe.**Raccord à compression avec joint en caoutchouc pour tube cuivre.*

Codice Code	Misura Size Dimensions	Per tubo For pipe Pour tube
9100TA 12 015	Ø 12 x 1/2"	Ø 12
9100TA 15 015	Ø 15 x 1/2"	Ø 15

9200TA

ADATTATORE A COMPRESSIONE CON TENUTA O-RING E ANELLO PTFE PER TUBO PEX E MULTISTRATO.

*Adapter for PEX/AL-PEX.**Raccord à compression avec O-Ring et anneau PTFE pour tubes PEX et multicouches.*

Codice Code	Misura Size Dimensions	Per tubo For pipe Pour tube
9200TA 16 12 015	16/12 x 1/2"	16 x 2

KIT COPRI TUBO SINGOLO

Tube cover set *single type*

Kit de couvre-tuyaux *type unique*

061TA

SET COPRITUBO IN OTTONE COMPLETO CON DUE ROSONI E TUBI. FINITURA CROMO.

Complete brass tube cover set with two sleeves and pipes. Chrome finishing.

Kit de couvre-tuyaux en laiton avec deux rosaces et tuyaux. Finition chromée.



Codice Code	Misura Size	Dimensions		
061TA.70	70 mm		1	40
061TA.160	160 mm		1	32

061BB

SET COPRITUBO IN OTTONE COMPLETO CON DUE ROSONI E TUBI. FINITURA BIANCA.

Complete brass tube cover set with two sleeves and pipes. White finishing.

Kit de couvre-tuyaux en laiton avec deux rosaces et tuyaux. Finition blanche.

RAL 9016



Codice Code	Misura Size	Dimensions		
061BB.70	70 mm		1	40
061BB.160	160 mm		1	32

061NN

SET COPRITUBO IN OTTONE COMPLETO CON DUE ROSONI E TUBI. FINITURA NERA.

Complete brass tube cover set with two sleeves and pipes. Black finishing.

Kit de couvre-tuyaux en laiton avec deux rosaces et tuyaux. Finition noire.

RAL 9004



Codice Code	Misura Size	Dimensions		
061NN.70	70 mm		1	40
061NN.160	160 mm		1	32

ISTRUZIONI DI INSTALLAZIONE KIT COPRI TUBO. TUBE COVER SET INSTALLATION. INSTALLATION KIT DE COUVRE-TUYAUX.



TAGLIARE IL COPRITUBO DELLA LUNGHEZZA NECESSARIA E SVASARE CON L'UTENSILE SVASATORE.
Cut the pipe cover to the required length and flare with the countersink tool.
Coupez le couvercle du tuyau à la longueur requise et évasez avec l'outil à fraiser.

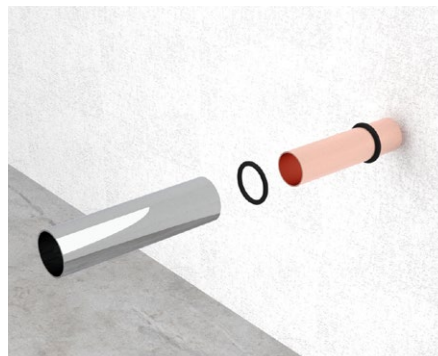

INFILARE LE GUARNIZIONI O-RINGS ED IL COPRITUBO.
Insert the O-rings and the pipe cover.
Insérer les joints O-rings et le couvre-tuyaux.

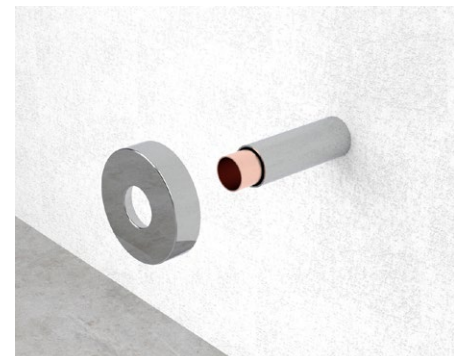

INSERIRE IL ROSONE.
Fit the cover rosette.
Insérez la rosace.

KIT COPRI TUBO DOPPIO

Tube cover set **double type**

Kit de couvre-tuyaux **type double**

062BB

SET COPRITUBO IN OTTONE COMPLETO CON UN ROSONE E TUBI. FINITURA BIANCA.

Complete brass tube cover set with one sleeve and pipes. White finishing.

Kit de couvre-tuyaux en laiton avec une rosace et tuyaux. Finition blanche.

PASSO 50 MM
Pitch 50mm
E.A. 50mm

RAL 9016



Codice Code	Misura Size	Dimensions		
062BB.70	70 mm		1	40
062BB.160	160 mm		1	32

062TA

SET COPRITUBO IN OTTONE COMPLETO CON UN ROSONE E TUBI. FINITURA CROMO.

Complete brass tube cover set with one sleeve and pipes. Chrome finishing.

Kit de couvre-tuyaux en laiton avec une rosace et tuyaux. Finition chromée.

PASSO 50 MM
Pitch 50mm
E.A. 50mm



Codice Code	Misura Size	Dimensions		
062TA.70	70 mm		1	40
062TA.160	160 mm		1	32

062NN

SET COPRITUBO IN OTTONE COMPLETO CON UN ROSONE E TUBI. FINITURA NERA.

Complete brass tube cover set with one sleeve and pipes. Black finishing.

Kit de couvre-tuyaux en laiton avec une rosace et tuyaux. Finition noire.

PASSO 50 MM
Pitch 50mm
E.A. 50mm

RAL 9004



Codice Code	Misura Size	Dimensions		
062NN.70	70 mm		1	40
062NN.160	160 mm		1	32



MONTARE LA VALVOLA AL RADIATORE.
Install the valve to the radiator.
Montez la valve sur le radiateur.

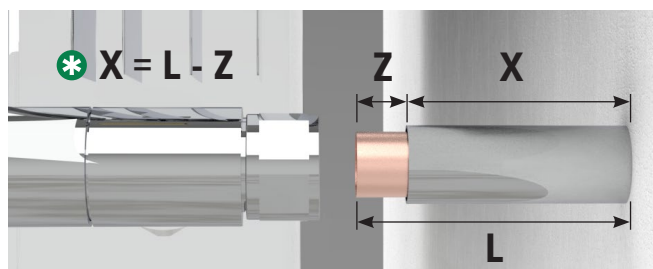

Fitting code	Tubo multistrato <i>multilayer pipe</i> <i>tube multicouche</i>	"Z" mm
9200.16.12.015	Ø16.12 x 1/2"	13
9200.16.12.020	Ø16.12 x 3/4"	13

Fitting code	Tubo rame <i>copper pipe</i> <i>tube cuivre</i>	"Z" mm
9100.12.015	Ø12 x 1/2"	16
9100.14.015	Ø14 x 1/2"	16
9100.15.015	Ø15 x 1/2"	16

Fitting code	Tubo rame <i>copper pipe</i> <i>tube cuivre</i>	"Z" mm
9100.12.020	Ø12 x 3/4"	24
9100.14.020	Ø14 x 3/4"	24
9100.15.020	Ø15 x 3/4"	24

SCALDASALVIETTE TONDO

Round towel

Sècheserviettes ronde

8020

- RADIATORE D'ARREDO TONDO IN ACCIAIO
- STAFFE A PARETE IN METALLO COLORATO O CROMATO
 - VALVOLE DI SFIATO
 - TAPPO CIECO
 - FINITURE DISPONIBILI:
BIANCO / NERO / CROMO

Round steel radiator

- Wall brackets in coloured or chromed metal
- Exhaust valve
- Blind cap
- Finishes available:
White / Black / Chrome

Radiateur décoratif acier ronde

- Supports muraux en métal coloré ou chromé
- Vanne de décompression
- Bouchon borgne
- Finitions disponibles:
Blanc / Noire / Chrome

ATTACCHI: 1/2" G
 PRESSIONE MASSIMA D'ESERCIZIO: 5 BAR
 TEMPERATURA MASSIMA D'ESERCIZIO: 95°C
 KIT COPRITUBO (PAG. 86)
 MISURE Ø 18 e Ø 35

Connections: 1/2" G

Maximum working pressure: 5 bar
 Max working temperature: 95°C
 Tube cover kit (pag. 86)
 Size Ø 18 and Ø 35

Connection: 1/2" G

Pression maximale de service: 5 bar
 Temperature maximale de service: 95°C
 Kit cache-tube (pag. 86)
 Dimensions Ø 18 et Ø 35



8020 *** 080



8020 *** 120



8020 *** 180



8020 TA

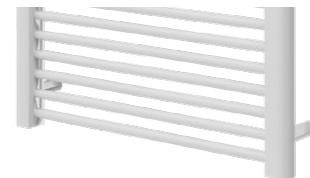

8020 BB



8020 NN

RESE TERMICHE - Thermal output
 UNI EN 442 (ΔT 50 K)

Watt=Kcal/h: 1,161
 Kcal/h=Watt x 1,161

Codice Code	Larghezza Width Largeur mm	Altezza Height Hauteur mm	Interasse Distance E.A. mm	Resa Output Watt W	Resa cromo Out. chrome Watt W	Capacità Capacity Capacité Lt	Peso Weight Poids Kg	Pz. Pc.	X = NN Nero / Black Noire RAL9004	X = BB Bianco / White Blanc RAL9016	X = TA Cromo Chrome / Crome
8020 "X" 50 080	500	800	465	375	262	3,2	6,5	1			
8020 "X" 60 080	600	800	565	440	308	3,4	7,8	1			
8020 "X" 50 120	500	1200	465	561	392	4,8	9,2	1			
8020 "X" 60 120	600	1200	565	659	461	5,5	10,4	1			
8020 "X" 50 180	500	1800	465	859	601	7,4	13,8	1			
8020 "X" 60 180	600	1800	565	1010	707	8,4	16,5	1			

SCALDASALVIETTE **QUADRO***Square towel**Sècheserviettes carrée***8025**

RADIATORE D'ARREDO QUADRO IN ACCIAIO

- STAFFE A PARETE IN METALLO COLORATO O CROMATO
- VALVOLE DI SFIATO
- TAPPO CIECO
- FINITURE DISPONIBILI:
BIANCO / NERO / CROMO

Square steel radiator

- Wall brackets in coloured or chromed metal
- Exhaust valve
- Blind cap
- Finishes available:
White / Black / Chrome

Radiateur décoratif acier carrée

- Supports muraux en métal coloré ou chromé
- Vanne de décompression
- Bouchon borgne
- Finitions disponibles:
Blanc / Noire / Chrome

ATTACCHI: 1/2" G

PRESSIONE MASSIMA D'ESERCIZIO: 5 BAR

TEMPERATURA MASSIMA D'ESERCIZIO: 95°C

MISURE □ 20x20 e □ 40x30

Connections: 1/2" G

Maximum working pressure: 5 bar

Max working temperature: 95°C

Size □ 20x20 and □ 40x30

Connection: 1/2" G

Pression maximale de service: 5 bar

Temperature maximale de service: 95°C

Dimensions □ 20x20 et □ 40x30



8025 *** 080



8025 *** 120



8025 *** 150



8025 *** 180

8025 TA

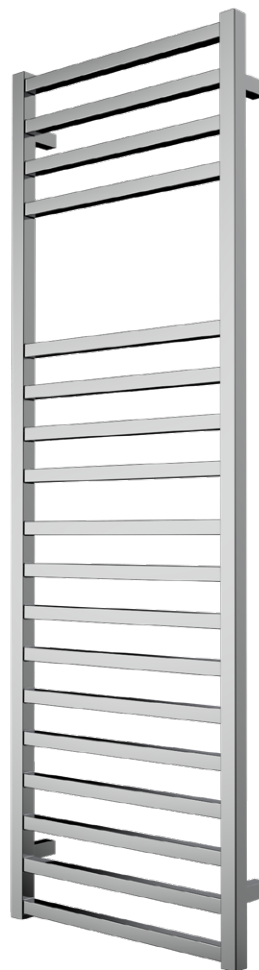

8025 BB

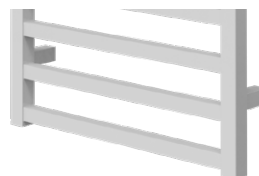

8025 NN

RESE TERMICHE - Thermal output
UNI EN 442 (ΔT 50 K)Watt=Kcal/h: 1,161
Kcal/h=Watt x 1,161

Codice Code	Larghezza Width Largeur mm	Altezza Height Hauteur mm	Interasse Distance E.A. mm	Resa Output Watt W	Resa cromo Out. chrome Watt W	Capacità Capacity Capacité Lt	Peso Weight Poids Kg	Pz. Pc.	X = NN Nero / Black Noire RAL9004	X = BB Bianco / White Blanc RAL9016	X = TA Cromo Chrome / Crome
8025 "X" 50 080	500	760	460	320	224	3,1	7,1	1			
8025 "X" 60 080	600	760	560	384	268	3,5	8,2	1			
8025 "X" 50 120	500	1260	460	603	422	4,9	11,1	1			
8025 "X" 60 120	600	1260	560	695	486	5,5	12,8	1			
8025 "X" 50 150	500	1510	460	607	425	5,92	13,2	1			
8025 "X" 60 150	600	1510	560	720	504	6,61	15,2	1			
8025 "X" 50 180	500	1910	460	892	624	8,85	18,5	1			
8025 "X" 60 180	600	1910	560	938	656	9,75	22,0	1			

VALVOLE H TERMOSTATIZZABILI D'ARREDO **FINITURA CROMO**

*Thermostatic H-valves **chrome finishing***

*Vannes H thermostatisable **finition chromée***

VALVOLA AD "H" IN OTTONE BITUBO IN OTTONE CROMATO.

- VITONE TERMOSTATIZZABILE
- DETENTORE MICROMETRICO
- CAPPuccio DI PROTEZIONE IN PLASTICA
- GUARNIZIONI DI TENUTA EPDM
- FILETTATURE SECONDO UNI ISO 228/1
- ATTACCO A COMPRESSIONE 3/4" EK
- LIMITI DI PRESSIONE 10 BAR (PN 10)
- LIMITI DI TEMPERATURA -20 +100 °C

Two-pipe brass "H" valve in chromed brass.

- Thermostatic valve
- Micrometric lockshield
- Plastic protective cap
- EPDM seals
- Threads according to UNI ISO 228/1
- Compression fitting 3/4" EK
- Pressure limits 10 bar (PN 10)
- Temperature range -20 +100 °C

Vanne «H» à deux tubes en laiton chromé.

- Vanne thermostatique
- Coude de réglage micrométrique
- Capuchon de protection en plastique
- Joints EPDM
- Filetages selon UNI ISO 228/1
- Raccord à compression 3/4" EK
- Limites de pression 10 bar (PN 10)
- Limites de température -20 +100 °C

COD340TA

RACCORDO M/M 3/4" x 1/2" PER VALVOLA AD H, CROMATO.

Fittings M/M 3/4" x 1/2" for H valve, chromium plated.

Raccords M/M 3/4" x 1/2" pour soupape de H, chromé.



Codice Code	Misura Size Dimensions
COD340TA 015	3/4" x 1/2"

9200TA

ADATTATORE A COMPRESSIONE CON TENUTA O-RING E ANELLO PTFE PER TUBO PEX E MULTISTRATO.

Adapter for PEX/AL-PEX.

Raccord à compression avec O-Ring et anneau PTFE pour tubes PEX et multicouches.



Codice Code	Misura Size Dimensions	Per tubo For pipe
9200TA 16 12 020	16/12 x 3/4"	16 x 2

9100TA

ADATTATORE A COMPRESSIONE CON TENUTA IN GOMMA PER TUBO RAME.

Adapter for copper pipe.

Raccord à compression avec joint en caoutchouc pour tube cuivre.



Codice Code	Misura Size Dimensions	Per tubo For pipe
9100TA 12 020	Ø 12 x 3/4"	Ø 12
9100TA 14 020	Ø 14 x 3/4"	Ø 14
9100TA 15 020	Ø 15 x 3/4"	Ø 15

2TT CC

TESTA TERMOSTATICA CON SENSORE A LIQUIDO.

Thermostatic head with liquid sensor.

Tête thermostatique avec capteur de liquide.



Codice Code	Misura Size Dimensions
2TT CC	M 30 x 1,5

343TA 3/4"

VALVOLA AD H TERMOSTATIZZABILE
A SQUADRA, SENZA RACCORDI.
FINITURA CROMO.

*Angle H valve thermostatic,
without fittings. Chrome finishing.*

*Vannes thermostatizable modèle H,
équerre, sans raccords.
Finition chromée.*



Codice	Code	Misura	Size	Dimensions	Int.	☐	📦
343TA	020	3/4"	x 3/4"	EK	50 mm	1	30

344TA 3/4"

VALVOLA AD H TERMOSTATIZZABILE
DIRITTA, SENZA RACCORDI.
FINITURA CROMO.

*Straight H valve thermostatic,
without fittings. Chrome finishing.*

*Vannes thermostatizable modèle H,
droite, sans raccords.
Finition chromée.*



Codice	Code	Misura	Size	Dimensions	Int.	☐	📦
344TA	020	3/4"	x 3/4"	EK	50 mm	1	30

343TA 1/2"

VALVOLA AD H TERMOSTATIZZABILE
A SQUADRA, CON RACCORDI.
FINITURA CROMO.

*Angle H valve thermostatic,
with fittings. Chrome finishing.*

*Vannes thermostatizable modèle H,
équerre, avec raccords.
Finition chromée.*



Codice	Code	Misura	Size	Dimensions	Int.	☐	📦
343TA	015	1/2"	x 3/4"	EK	50 mm	1	30

344TA 1/2"

VALVOLA AD H TERMOSTATIZZABILE
DIRITTA, CON RACCORDI.
FINITURA CROMO.

*Straight H valve thermostatic,
with fittings. Chrome finishing.*

*Vannes thermostatizable modèle H,
droite, avec raccords.
Finition chromée.*



Codice	Code	Misura	Size	Dimensions	Int.	☐	📦
344TA	015	1/2"	x 3/4"	EK	50 mm	1	30

343KCR - 343KCM

KIT VALVOLA AD H TERMOSTATIZZABILE
A SQUADRA. FINITURA CROMO.

*Kit angle thermostatic H valve.
Chrome finishing.*

*Set vannes thermostatizable modèle H,
équerre. Finition chromée.*



9100TA **9200TA**



Codice	Code	Misura	Size	Dimensions	Tubo pipe tube
343KC	015 R 12	1/2"	x 3/4"	- 9100TA incluso/included	Ø 12
343KC	015 R 14	1/2"	x 3/4"	- 9100TA incluso/included	Ø 14
343KC	015 R 15	1/2"	x 3/4"	- 9100TA incluso/included	Ø 15
343KC	015 M 16 12	1/2"	x 3/4"	- 9200TA incluso/included	16 x 2

344KCR - 344KCM

KIT VALVOLA AD H TERMOSTATIZZABILE
DIRITTA. FINITURA CROMO.

*Kit straight thermostatic H valve.
Chrome finishing.*

*Set vannes thermostatizable modèle H,
droite. Finition chromée.*



9100TA **9200TA**



Codice	Code	Misura	Size	Dimensions	Tubo pipe tube
344KC	015 R 12	1/2"	x 3/4"	- 9100TA incluso/included	Ø 12
344KC	015 R 14	1/2"	x 3/4"	- 9100TA incluso/included	Ø 14
344KC	015 R 15	1/2"	x 3/4"	- 9100TA incluso/included	Ø 15
344KC	015 M 16 12	1/2"	x 3/4"	- 9200TA incluso/included	16 x 2

VALVOLE H TERMOSTATIZZABILI D'ARREDO **FINITURA BIANCA**

*Thermostatic H-valves **white finishing***

*Vannes H thermostatisable **finition blanche***

VALVOLA AD "H" IN OTTONE BITUBO VERNICIATO RAL9016

- VITONE TERMOSTATIZZABILE
- DETENTORE MICROMETRICO
- CAPPUCCIO DI PROTEZIONE IN PLASTICA
- GUARNIZIONI DI TENUTA EPDM
- FILETTATURE SECONDO UNI ISO 228/1
- ATTACCO A COMPRESSIONE 3/4" EK
- LIMITI DI PRESSIONE 10 BAR (PN 10)
- LIMITI DI TEMPERATURA -20 +100 °C

"H" valve in two-pipe brass painted RAL9016

- Thermostatic valve
- Micrometric lockshield
- Plastic protective cap
- EPDM seals
- Threads according to UNI ISO 228/1
- Compression fitting 3/4" EK
- Pressure limits 10 bar (PN 10)
- Temperature range -20 +100 °C

Vanne "H" en laiton deux tubes peint RAL9016

- Vanne thermostatique
- Coude de réglage micrométrique
- Capuchon de protection en plastique
- Joints EPDM
- Filetages selon UNI ISO 228/1
- Raccord à compression 3/4" EK
- Limites de pression 10 bar (PN 10)
- Limites de température -20 +100 °C

COD340

RACCORDO M/M 3/4" x 1/2" PER VALVOLA AD H.

Fittings M/M 3/4" x 1/2" for H valve.

Raccords M/M 3/4" x 1/2" pour soupape de H.



Codice Code	Misura Size Dimensions
COD340 015	3/4" x 1/2"

9200BB

ADATTATORE A COMPRESSIONE CON TENUTA O-RING E ANELLO PTFE PER TUBO PEX E MULTISTRATO. FINITURA BIANCA.

Adapter for PEX/AL-PEX. White finishing.

Raccord à compression avec O-Ring et anneau PTFE pour tubes PEX et multicouches. Finition blanche.



Codice Code	Misura Size Dimensions	Per tubo For pipe
9200BB 16 12 020	16/12 x 3/4"	16 x 2

9100BB

ADATTATORE A COMPRESSIONE CON TENUTA IN GOMMA PER TUBO RAME. FINITURA BIANCA.

Adapter for copper pipe. White finishing.

Raccord à compression avec joint en caoutchouc pour tube cuivre. Finition blanche.



Codice Code	Misura Size Dimensions	Per tubo For pipe
9100BB 12 020	Ø 12 x 3/4"	Ø 12
9100BB 14 020	Ø 14 x 3/4"	Ø 14
9100BB 15 020	Ø 15 x 3/4"	Ø 15

2TT BB

TESTA TERMOSTATICA CON SENSORE A LIQUIDO. FINITURA BIANCA.

Thermostatic head with liquid sensor. White finishing.

Tête thermostatique avec capteur de liquide. Finition blanche.



Codice Code	Misura Size Dimensions
2TT BB	M 30 x 1,5

343TB 3/4"

VALVOLE AD H TERMOSTATIZZABILE
A SQUADRA, SENZA RACCORDI.
FINITURA BIANCA.

*Angle H valve thermostatic,
without fittings. White finishing.*

*Vannes thermostatizable modèle H,
équerre, sans raccords.
Finition blanche.*



Codice	Code	Misura	Size	Dimensions	Int.	📦	📦
343TB	020	3/4"	x 3/4"	EK	50 mm	1	30

344TB 3/4"

VALVOLE AD H TERMOSTATIZZABILE
DIRITTA, SENZA RACCORDI.
FINITURA BIANCA.

*Straight H valve thermostatic,
without fittings. White finishing.*

*Vannes thermostatizable modèle H,
droite, sans raccords.
Finition blanche.*



Codice	Code	Misura	Size	Dimensions	Int.	📦	📦
344TB	020	3/4"	x 3/4"	EK	50 mm	1	30

343TB 1/2"

VALVOLE AD H TERMOSTATIZZABILE
A SQUADRA, CON RACCORDI.
FINITURA BIANCA.

*Angle H valve thermostatic,
with fittings. White finishing.*

*Vannes thermostatizable modèle H,
équerre, avec raccords.
Finition blanche.*



Codice	Code	Misura	Size	Dimensions	Int.	📦	📦
343TB	015	1/2"	x 3/4"	EK	50 mm	1	30

344TB 1/2"

VALVOLE AD H TERMOSTATIZZABILE
DIRITTA, CON RACCORDI.
FINITURA BIANCA.

*Straight H valve thermostatic,
with fittings. White finishing.*

*Vannes thermostatizable modèle H,
droite, avec raccords.
Finition blanche.*



Codice	Code	Misura	Size	Dimensions	Int.	📦	📦
344TB	015	1/2"	x 3/4"	EK	50 mm	1	30

343KBR - 343KBM

KIT VALVOLE AD H TERMOSTATIZZABILE
A SQUADRA. FINITURA BIANCA.

*Kit angle thermostatic H valve.
White finishing.*

*Set vannes thermostatizable modèle H,
équerre. Finition blanche.*

9100BB

9200BB



Codice	Code	Misura	Size	Dimensions	Tubo pipe tube
343KB	015 R 12	1/2"	x 3/4"	- 9100BB incluso/included	Ø 12
343KB	015 R 14	1/2"	x 3/4"	- 9100BB incluso/included	Ø 14
343KB	015 R 15	1/2"	x 3/4"	- 9100BB incluso/included	Ø 15
343KB	015 M 16 12	1/2"	x 3/4"	- 9200BB incluso/included	16 x 2

344KBR - 343KBM

KIT VALVOLE AD H TERMOSTATIZZABILE
DIRITTA. FINITURA BIANCA.

*Kit straight thermostatic H valve.
White finishing.*

*Set vannes thermostatizable modèle H,
droite. Finition blanche.*

9100BB

9200BB



Codice	Code	Misura	Size	Dimensions	Tubo pipe tube
344KB	015 R 12	1/2"	x 3/4"	- 9100BB incluso/included	Ø 12
344KB	015 R 14	1/2"	x 3/4"	- 9100BB incluso/included	Ø 14
344KB	015 R 15	1/2"	x 3/4"	- 9100BB incluso/included	Ø 15
344KB	015 M 16 12	1/2"	x 3/4"	- 9200BB incluso/included	16 x 2

VALVOLE H TERMOSTATIZZABILI D'ARREDO **FINITURA NERA**

*Thermostatic H-valves **black finishing***

*Vannes H thermostatisable **finition noire***

VALVOLA AD "H" IN OTTONE BITUBO VERNICIATO RAL9004

- VITONE TERMOSTATIZZABILE
- DETENTORE MICROMETRICO
- CAPPuccio DI PROTEZIONE IN PLASTICA
- GUARNIZIONI DI TENUTA EPDM
- FILETTATURE SECONDO UNI ISO 228/1
- ATTACCO A COMPRESSIONE 3/4" EK
- LIMITI DI PRESSIONE 10 BAR (PN 10)
- LIMITI DI TEMPERATURA -20 +100 °C

"H" valve in two-pipe brass painted RAL9004

- Thermostatic valve
- Micrometric lockshield
- Plastic protective cap
- EPDM seals
- Threads according to UNI ISO 228/1
- Compression fitting 3/4" EK
- Pressure limits 10 bar (PN 10)
- Temperature range -20 +100 °C

Vanne "H" en laiton deux tubes peint RAL9004

- Vanne thermostatique
- Coude de réglage micrométrique
- Capuchon de protection en plastique
- Joints EPDM
- Filetages selon UNI ISO 228/1
- Raccord à compression 3/4" EK
- Limites de pression 10 bar (PN 10)
- Limites de température -20 +100 °C

COD340

RACCORDO M/M 3/4" x 1/2" PER VALVOLA AD H.

Fittings M/M 3/4" x 1/2" for H valve.

Raccords M/M 3/4" x 1/2" pour soupape de H.



Codice Code	Misura Size Dimensions
COD340 015	3/4" x 1/2"

9200NN

ADATTATORE A COMPRESSIONE CON TENUTA O-RING E ANELLO PTFE PER TUBO PEX E MULTISTRATO. FINITURA NERA.

Adapter for PEX/AL-PEX. Black finishing.

Raccord à compression avec O-Ring et anneau PTFE pour tubes PEX et multicouches. Finition noire.



Codice Code	Misura Size Dimensions	Per tubo For pipe
9200NN 16 12 020	16/12 x 3/4"	16 x 2

9100NN

ADATTATORE A COMPRESSIONE CON TENUTA IN GOMMA PER TUBO RAME. FINITURA NERA.

Adapter for copper pipe. Black finishing.

Raccord à compression avec joint en caoutchouc pour tube cuivre. Finition noire.



Codice Code	Misura Size Dimensions	Per tubo For pipe
9100NN 12 020	Ø 12 x 3/4"	Ø 12
9100NN 14 020	Ø 14 x 3/4"	Ø 14
9100NN 15 020	Ø 15 x 3/4"	Ø 15

2TT NN

TESTA TERMOSTATICA CON SENSORE A LIQUIDO. FINITURA NERA.

Thermostatic head with liquid sensor. Black finishing.

Tête thermostatique avec capteur de liquide. Finition noire.



Codice Code	Misura Size Dimensions
2TT NN	M 30 x 1,5

343NN 3/4"

VALVOLA AD H TERMOSTATIZZABILE A SQUADRA, SENZA RACCORDI. FINITURA NERA.

Angle H valve thermostatic, without fittings. Black finishing.

Vannes thermostatizable modèle H, équerre, sans raccords. Finition noire.



Codice	Code	Misura	Size	Dimensions	Int.		
343NN	020		3/4"	x 3/4" EK	50 mm	1	30

344NN 3/4"

VALVOLA AD H TERMOSTATIZZABILE DIRITTA, SENZA RACCORDI. FINITURA NERA.

Straight H valve thermostatic, without fittings. Black finishing.

Vannes thermostatizable modèle H, droite, sans raccords. Finition noire.



Codice	Code	Misura	Size	Dimensions	Int.		
344NN	020		3/4"	x 3/4" EK	50 mm	1	30

343NN 1/2"

VALVOLA AD H TERMOSTATIZZABILE A SQUADRA, CON RACCORDI. FINITURA NERA.

Angle H valve thermostatic, with fittings. Black finishing.

Vannes thermostatizable modèle H, équerre, avec raccords. Finition noire.



Codice	Code	Misura	Size	Dimensions	Int.		
343NN	015		1/2"	x 3/4" EK	50 mm	1	30

344NN 1/2"

VALVOLA AD H TERMOSTATIZZABILE DIRITTA, CON RACCORDI. FINITURA NERA.

Straight H valve thermostatic, with fittings. Black finishing.

Vannes thermostatizable modèle H, droite, avec raccords. Finition noire.



Codice	Code	Misura	Size	Dimensions	Int.		
344NN	015		1/2"	x 3/4" EK	50 mm	1	30

343KNNR - 343KNNM

KIT VALVOLA AD H TERMOSTATIZZABILE A SQUADRA. FINITURA NERA.

Kit angle thermostatic H valve. Black finishing.

Set vannes thermostatizable modèle H, équerre. Finition noire.



9100NN **9200NN**



Codice	Code	Misura	Size	Dimensions	Tubo pipe tube
343KNN	015 R 12	1/2" x 3/4"	-	9100NN incluso/included	Ø 12
343KNN	015 R 14	1/2" x 3/4"	-	9100NN incluso/included	Ø 14
343KNN	015 R 15	1/2" x 3/4"	-	9100NN incluso/included	Ø 15
343KNN	015 M 16 12	1/2" x 3/4"	-	9200NN incluso/included	16 x 2

344KNNR - 344KNNM

KIT VALVOLA AD H TERMOSTATIZZABILE DIRITTA. FINITURA NERA.

Kit straight thermostatic H valve. Black finishing.

Set vannes thermostatizable modèle H, droite. Finition noire.



9100NN **9200NN**



Codice	Code	Misura	Size	Dimensions	Tubo pipe tube
344KNN	015 R 12	1/2" x 3/4"	-	9100NN incluso/included	Ø 12
344KNN	015 R 14	1/2" x 3/4"	-	9100NN incluso/included	Ø 14
344KNN	015 R 15	1/2" x 3/4"	-	9100NN incluso/included	Ø 15
344KNN	015 M 16 12	1/2" x 3/4"	-	9200NN incluso/included	16 x 2

VALVOLE TERMOSTATIZZABILI MONOTUBO

Thermostatic valves monotube

Vannes thermostatisable monotube

VALVOLA TERMOSTATIZZABILE MONO-BITUBO IN OTTONE STAMPATO.

- FINITURE: NICKEL, CROMO, RAL 9016 E RAL 9004
- VITONE TERMOSTATIZZABILE
- DETENTORE MICROMETRICO
- BY-PASS
- CAPPUCCIO DI PROTEZIONE IN PLASTICA
- GUARNIZIONI DI TENUTA EPDM
- FILETTATURE SECONDO UNI ISO 228/1
- ATTACCO A COMPRESIONE 3/4" EK
- LIMITI DI PRESSIONE 10 BAR (PN 10)
- LIMITI DI TEMPERATURA -10 +100 °C

Single-double pipe thermostatic valve in forged brass.

- Finishes: nickel, chrome, RAL 9016 and RAL 9004
- Thermostatic valve
- Micrometric lockshield
- By-Pass
- Plastic protective cap
- EPDM seals
- Threads according to UNI ISO 228/1
- Compression fitting 3/4" EK
- Pressure limits 10 bar (PN 10)
- Temperature range -10 +100 °C

Vanne thermostatique monotube en laiton pressé.

- Finitions: nickel, chrome, RAL 9016 et RAL 9004
- Vanne thermostatique
- Bouclier micrométrique
- By-Pass
- Capuchon de protection en plastique
- Joints EPDM
- Filetages selon UNI ISO 228/1
- Raccord à compression 3/4" EK
- Limites de pression 10 bar (PN 10)
- Limites de température -10 +100 °C



351CP

VALVOLA TERMOSTATIZZABILE ANGOLO 3/4" EK MONO/BITUBO CON BY-PASS E DETENTORE. FINITURA SABBBIATA NICHELATA.

Angle thermostatic mono/bitube valve 3/4" EK with by-pass and lockshield. Sand blasted nickel finishing.

Vanne mono / bitube thermostatique équerre 3/4" EK avec by-pass et verrouillage. Finition nickel sablée.



352CP

VALVOLA TERMOSTATIZZABILE DIRITTA 3/4" EK MONO/BITUBO CON BY-PASS E DETENTORE. FINITURA SABBBIATA NICHELATA.

Straight thermostatic mono/bitube valve 3/4" EK with by-pass and lockshield. Sand blasted nickel finishing.

Vanne mono / bitube thermostatique droite 3/4" EK avec by-pass et verrouillage. Finition nickel sablée.



Codice Code	Misura Size Dimensions	Int.	☐	📦
351CP 015	1/2" x 3/4" EK	50 mm	1	12

Codice Code	Misura Size Dimensions	Int.	☐	📦
352CP 015	1/2" x 3/4" EK	50 mm	1	12

351TA

VALVOLA TERMOSTATIZZABILE
ANGOLO 3/4" EK MONO/BITUBO
CON BY-PASS E DETENTORE.
FINITURA CROMATA LUCIDA.

*Angle thermostatic mono/bitube
valve 3/4" EK with by-pass
and lockshield.
Polished chrome finish.*

*Vanne mono / bitube
thermostatique équerre 3/4" EK
avec by-pass et verrouillage.
Finition chrome poli.*



Codice Code	Misura Size Dimensions	Int.		
351TA 015	1/2" x 3/4" EK	50 mm	1	12

352TA

VALVOLA TERMOSTATIZZABILE
DIRITTA 3/4" EK MONO/BITUBO
CON BY-PASS E DETENTORE.
FINITURA CROMATA LUCIDA.

*Straight thermostatic mono/
bitube valve 3/4" EK with
by-pass and lockshield.
Polished chrome finish.*

*Vanne mono / bitube
thermostatique droite
3/4" EK avec by-pass
et verrouillage.
Finition chrome poli.*



Codice Code	Misura Size Dimensions	Int.		
352TA 015	1/2" x 3/4" EK	50 mm	1	12

351TB

VALVOLA TERMOSTATIZZABILE
ANGOLO 3/4" EK MONO/BITUBO
CON BY-PASS E DETENTORE.
FINITURA BIANCA.

*Angle thermostatic mono/bitube
valve 3/4" EK with by-pass
and lockshield. White finishing.*

*Vanne mono / bitube
thermostatique équerre 3/4" EK
avec by-pass et verrouillage.
Finition blanche.*

RAL 9016



Codice Code	Misura Size Dimensions	Int.		
351TB 015	1/2" x 3/4" EK	50 mm	1	12

352TB

VALVOLA TERMOSTATIZZABILE
DIRITTA 3/4" EK MONO/BITUBO
CON BY-PASS E DETENTORE.
FINITURA BIANCA.

*Straight thermostatic mono/bitube
valve 3/4" EK with by-pass and
lockshield. White finishing.*

*Vanne mono / bitube
thermostatique droite
3/4" EK avec by-pass
et verrouillage.
Finition blanche.*

RAL 9016



Codice Code	Misura Size Dimensions	Int.		
352TB 015	1/2" x 3/4" EK	50 mm	1	12

351NN

VALVOLA TERMOSTATIZZABILE
ANGOLO 3/4" EK MONO/BITUBO
CON BY-PASS E DETENTORE.
FINITURA NERA.

*Angle thermostatic mono/bitube
valve 3/4" EK with by-pass
and lockshield. Black finishing.*

*Vanne mono / bitube
thermostatique équerre 3/4" EK
avec by-pass et verrouillage.
Finition noire.*

RAL 9004



Codice Code	Misura Size Dimensions	Int.		
351NN 015	1/2" x 3/4" EK	50 mm	1	12

352NN

VALVOLA TERMOSTATIZZABILE
DIRITTA 3/4" EK MONO/BITUBO
CON BY-PASS E DETENTORE.
FINITURA NERA.

*Straight thermostatic mono/bitube
valve 3/4" EK with by-pass and
lockshield. Black finishing.*

*Vanne mono / bitube
thermostatique droite
3/4" EK avec by-pass
et verrouillage.
Finition noire.*

RAL 9004



Codice Code	Misura Size Dimensions	Int.		
352NN 015	1/2" x 3/4" EK	50 mm	1	12

VALVOLA TERMOSTATIZZABILE CON PORTA RESISTENZA ELETTRICA PER FUNZIONAMENTO MISTO

Thermostatic valve with electrical resistance holder for mixed use

Vanne thermostatique avec support de résistance électrique pour un usage mixte

VALVOLA TERMOSTATIZZABILE CON PORTA RESISTENZA ELETTRICA PER FUNZIONAMENTO MISTO IN OTTONE STAMPATO.

- FINITURE: CROMO, RAL 9016 E RAL 9004
- VITONE TERMOSTATIZZABILE
- DETENTORE MICROMETRICO
- CAPPUCCIO DI PROTEZIONE IN PLASTICA
- GUARNIZIONI DI TENUTA EPDM
- FILETTATURE SECONDO UNI ISO 228/1
- ATTACCO A COMPRESSIONE 3/4" EK
- LIMITI DI PRESSIONE 10 BAR (PN 10)
- LIMITI DI TEMPERATURA -10 +100 °C

Thermostatic valve with electrical resistance holder for mixed use made in forged brass.

- Finishes: chrome, RAL 9016 and RAL 9004
- Thermostatic valve
- Micrometric lockshield
- Plastic protective cap
- EPDM seals
- Threads according to UNI ISO 228/1
- Compression fitting 3/4" EK
- Pressure limits 10 bar (PN 10)
- Temperature range -10 +100 °C

Vanne thermostatique avec support de résistance électrique pour un usage mixte fabriqué en laiton pressé.

- Finitions: chromée, RAL 9016 et RAL 9004
- Vanne thermostatique
- Bouclier micrométrique
- Capuchon de protection en plastique
- Joints EPDM
- Filetages selon UNI ISO 228/1
- Raccord à compression 3/4" EK
- Limites de pression 10 bar (PN 10)
- Limites de température -10 +100 °C

349TA

VALVOLA H TERMOSTATIZZABILE CON PORTA RESISTENZA ELETTRICA PER FUNZIONAMENTO MISTO. FINITURA CROMATA.

H-thermostatic valve with electrical resistance holder for a mixed use. Chrome finishing.

Vanne H-thermostatique avec support de résistance électrique pour un usage mixte. Finition chromée.



Codice	Code	Misura Size Dimensions	Int.	1	20
349TA	015	1/2" x 3/4" EK	50 mm	1	20

349KCR - 349KCM

KIT VALVOLA H TERMOSTATIZZABILE CON PORTA RESISTENZA ELETTRICA PER FUNZIONAMENTO MISTO. FINITURA CROMATA.

Kit H-thermostatic valve with electrical resistance holder for mixed use. Chrome finishing.

Set vanne H-thermostatique avec support de résistance électrique pour un usage mixte. Finition chromée.



9100TA 9200TA



Codice	Code	Misura Size Dimensions	Tube pipe tube
349KC	015 R	12 1/2" x 3/4" - 9100TA incluso/included	Ø 12
349KC	015 R	14 1/2" x 3/4" - 9100TA incluso/included	Ø 14
349KC	015 R	15 1/2" x 3/4" - 9100TA incluso/included	Ø 15
349KC	015 M	16 1/2" x 3/4" - 9200TA incluso/included	16 x 2

349TB

VALVOLA H TERMOSTATIZZABILE CON PORTA RESISTENZA ELETTRICA PER FUNZIONAMENTO MISTO. FINITURA BIANCA.

H-thermostatic valve with electrical resistance holder for a mixed use. White finishing.

Vanne H-thermostatique avec support de résistance électrique pour un usage mixte. Finition blanche.

RAL 9016



Codice	Code	Misura	Size	Dimensions	Int.		
349TB	015	1/2"	x 3/4"	EK	50 mm	1	20

349KBR - 349KBM

KIT VALVOLA H TERMOSTATIZZABILE CON PORTA RESISTENZA ELETTRICA PER FUNZIONAMENTO MISTO. FINITURA BIANCA.

Kit H-thermostatic valve with electrical resistance holder for mixed use. White finishing.

Set vanne H-thermostatique avec support de résistance électrique pour un usage mixte. Finition blanche.

RAL 9016

9100BB**9200BB**

Codice	Code	Misura	Size	Dimensions	Tube	pipe tube
349KB	015 R	12	1/2" x 3/4"	- 9100BB incluso/included		Ø 12
349KB	015 R	14	1/2" x 3/4"	- 9100BB incluso/included		Ø 14
349KB	015 R	15	1/2" x 3/4"	- 9100BB incluso/included		Ø 15
349KB	015 M	16 12	1/2" x 3/4"	- 9200BB incluso/included		16 x 2

349NN

VALVOLA H TERMOSTATIZZABILE CON PORTA RESISTENZA ELETTRICA PER FUNZIONAMENTO MISTO. FINITURA NERA.

H-thermostatic valve with electrical resistance holder for a mixed use. Black finishing.

Vanne H-thermostatique avec support de résistance électrique pour un usage mixte. Finition noire.

RAL 9004



Codice	Code	Misura	Size	Dimensions	Int.		
349NN	015	1/2"	x 3/4"	EK	50 mm	1	20

349KNNR - 349KNNM

KIT VALVOLA H TERMOSTATIZZABILE CON PORTA RESISTENZA ELETTRICA PER FUNZIONAMENTO MISTO. FINITURA NERA.

Kit H-thermostatic valve with electrical resistance holder for mixed use. Black finishing.

Set vanne H-thermostatique avec support de résistance électrique pour un usage mixte. Finition noire.

RAL 9004

9100NN**9200NN**

Codice	Code	Misura	Size	Dimensions	Tube	pipe tube
349KNN	015 R	12	1/2" x 3/4"	- 9100NN incluso/included		Ø 12
349KNN	015 R	14	1/2" x 3/4"	- 9100NN incluso/included		Ø 14
349KNN	015 R	15	1/2" x 3/4"	- 9100NN incluso/included		Ø 15
349KNN	015 M	16 12	1/2" x 3/4"	- 9200NN incluso/included		16 x 2

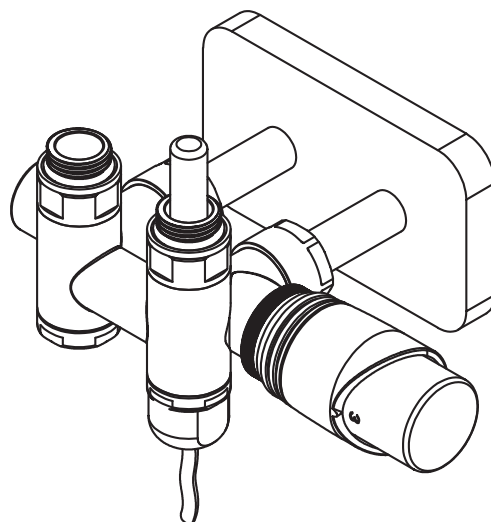

VALVOLA TERMOSTATIZZABILE CON PORTA RESISTENZA ELETTRICA PER FUNZIONAMENTO MISTO FINITURA CROMO

Thermostatic valve with electrical resistance holder for mixed use, chrome finishing

Vanne thermostatique avec support de résistance électrique pour un usage mixte, finition chromée

120TA S

VALVOLA TERMOSTATIZZABILE CON PORTA RESISTENZA ELETTRICA PER FUNZIONAMENTO MISTO. FINITURA CROMATA.

Thermostatic valve with electrical resistance holder for mixed use. Chrome finishing.

Vanne thermostatique avec support de résistance électrique pour un usage mixte. Finition chromée.



SINISTRA
Left
Gauche

Codice Code	Misura Size Dimensions	📦	📦
120TA 015 S	1/2" x 3/4" EK sinistra - left - gauche	15	60

320TA D

DETTENORE CON PORTA RESISTENZA ELETTRICA PER FUNZIONAMENTO MISTO. FINITURA CROMATA.

Lockshield with electrical resistance holder for mixed use. Chrome finishing.

Détendeur de radiateur avec support de résistance électrique pour un usage mixte. Finition chromée.



DESTRA
Right
Droite

Codice Code	Misura Size Dimensions	📦	📦
320TA 015 D	1/2" x 3/4" EK destra - right - droite	15	60

120TA

VALVOLE TERMOSTATIZZABILI A SQUADRA CON PORTA RESISTENZA ELETTRICA PER FUNZIONAMENTO MISTO. FINITURA CROMO. VALVOLA TERMOSTATIZZABILE A SINISTRA.

Angle thermostatic valves with electrical resistance holder for mixed use. Chrome finishing. Thermostatically controlled valve to the left.

Vannes thermostatables à coulisse avec porte résistance électrique pour fonctionnement mixte. Finition chromée. Commande thermostatique vanne à la gauche.



SINISTRA >
Left
Gauche

Codice Code	Misura Size Dimensions
120TA 015	1/2" x 3/4" EK Coppia - Pair - Couple

120KCR - 120KCM

KIT VALVOLE TERMOSTATIZZABILI A SQUADRA CON PORTA RESISTENZA ELETTRICA PER FUNZIONAMENTO MISTO. FINITURA CROMO. VALVOLA TERMOSTATIZZABILE A SINISTRA.

Kit angle thermostatic valves with electrical resistance holder for mixed use. Chrome finishing. Thermostatically controlled valve to the left.

Set vannes thermostatables à coulisse avec porte résistance électrique pour fonctionnement mixte. Finition chromée. Commande thermostatique vanne à la gauche.

9100TA

9200TA



Codice Code	Misura Size Dimensions	Tube pipe tube
120KC 015 R 12	1/2" x 3/4" - 9100TA incluso/included	Ø 12
120KC 015 R 14	1/2" x 3/4" - 9100TA incluso/included	Ø 14
120KC 015 R 15	1/2" x 3/4" - 9100TA incluso/included	Ø 15
120KC 015 M 16 12	1/2" x 3/4" - 9200TA incluso/included	16 x 2

320TA S

DETENTORE CON PORTA RESISTENZA ELETTRICA
PER FUNZIONAMENTO MISTO. FINITURA CROMATA.

*Lockshield with electrical resistance holder for mixed use.
Chrome finishing.*

*Détendeur de radiateur avec support
de résistance électrique
pour un usage mixte.
Finition chromée.*



SINISTRA
*Left
Gauche*

Codice Code	Misura Size Dimensions		
320TA 015 S	1/2" x 3/4" EK sinistra - left - gauche	15	60

120TA D

VALVOLA TERMOSTATIZZABILE CON PORTA RESISTENZA ELETTRICA
PER FUNZIONAMENTO MISTO. FINITURA CROMATA.

*Thermostatic valve with electrical resistance holder for mixed use.
Chrome finishing.*

*Vanne thermostatique avec support
de résistance électrique
pour un usage mixte.
Finition chromée.*



DESTRA
*Right
Droite*

Codice Code	Misura Size Dimensions		
120TA 015 D	1/2" x 3/4" EK destra - right - droite	15	60

125TA

VALVOLE TERMOSTATIZZABILI A SQUADRA CON
PORTA RESISTENZA ELETTRICA PER FUNZIONAMENTO
MISTO. FINITURA CROMO. VALVOLA
TERMOSTATIZZABILE A DESTRA.

*Angle thermostatic valves
with electrical resistance
holder for mixed use.
Chrome finishing.
Thermostatically controlled
valve to the right.*

*Vannes thermostatables
à coulisse avec porte résistance
électrique pour fonctionnement
mixte. Finition chromée.
Comande thermostatique
vanne à la droite.*



DESTRA >
*Right
Droite*

Codice Code	Misura Size Dimensions
125TA 015	1/2" x 3/4" EK Coppia - Pair - Couple

125KCR - 125KCM

KIT VALVOLE TERMOSTATIZZABILI A SQUADRA CON
PORTA RESISTENZA ELETTRICA PER FUNZIONAMENTO
MISTO. FINITURA CROMO. VALVOLA
TERMOSTATIZZABILE A DESTRA.

*Kit angle thermostatic valves with electrical
resistance holder for mixed use. Chrome finishing.
Thermostatically controlled valve to the right.*

*Set vannes thermostatables à coulisse
avec porte résistance électrique pour
fonctionnement mixte. Finition chromée.
Comande thermostatique vanne à la droite.*

9100TA

9200TA



Codice Code	Misura Size Dimensions	Tube pipe tube
125KC 015 R 12	1/2" x 3/4" - 9100TA incluso/included	Ø 12
125KC 015 R 14	1/2" x 3/4" - 9100TA incluso/included	Ø 14
125KC 015 R 15	1/2" x 3/4" - 9100TA incluso/included	Ø 15
125KC 015 M 16 12	1/2" x 3/4" - 9200TA incluso/included	16 x 2

2TT CC

TESTA TERMOSTATICA CON SENSORE A LIQUIDO.

Thermostatic head with liquid sensor.

Tête thermostatique avec capteur de liquide.



Codice Code	Misura Size Dimensions
2TT CC	M 30 x 1,5

VALVOLA TERMOSTATIZZABILE CON PORTA RESISTENZA ELETTRICA PER FUNZIONAMENTO MISTO FINITURA BIANCA

Thermostatic valve with electrical resistance holder for mixed use, white finishing

Vanne thermostatique avec support de résistance électrique pour un usage mixte, finition blanche

120TB S

VALVOLA TERMOSTATIZZABILE CON PORTA RESISTENZA ELETTRICA PER FUNZIONAMENTO MISTO. FINITURA BIANCA.

Thermostatic valve with electrical resistance holder for mixed use. White finishing.

Vanne thermostatique avec support de résistance électrique pour un usage mixte. Finition blanche.

RAL 9016



SINISTRA
Left
Gauche

Codice Code	Misura Size Dimensions		
120TB 015 S	1/2" x 3/4" EK sinistra - left - gauche	15	60

320TB D

DETENTORE CON PORTA RESISTENZA ELETTRICA PER FUNZIONAMENTO MISTO. FINITURA BIANCA.

Lockshield with electrical resistance holder for mixed use. White finishing.

Détendeur de radiateur avec support de résistance électrique pour un usage mixte. Finition blanche.

RAL 9016



DESTRA
Right
Droite

Codice Code	Misura Size Dimensions		
320TB 015 D	1/2" x 3/4" EK destra - right - droite	15	60

120TB

VALVOLE TERMOSTATIZZABILI A SQUADRA CON PORTA RESISTENZA ELETTRICA PER FUNZIONAMENTO MISTO. FINITURA BIANCA. VALVOLA TERMOSTATIZZABILE A SINISTRA.

Angle thermostatic valves with electrical resistance holder for mixed use. White finishing. Thermostatically controlled valve to the left.

Vannes thermostatables à coulisse avec porte résistance électrique pour fonctionnement mixte. Finition blanche. Comande thermostatique vanne à la gauche.



SINISTRA >
Left
Gauche

Codice Code	Misura Size Dimensions
120TB 015	1/2" x 3/4" EK Coppia - Pair - Couple

120KBR - 120KBM

KIT VALVOLE TERMOSTATIZZABILI A SQUADRA CON PORTA RESISTENZA ELETTRICA PER FUNZIONAMENTO MISTO. FINITURA BIANCA. VALVOLA TERMOSTATIZZABILE A SINISTRA.

Kit angle thermostatic valves with electrical resistance holder for mixed use. White finishing. Thermostatically controlled valve to the left.

Set vannes thermostatables à coulisse avec porte résistance électrique pour fonctionnement mixte. Finition blanche. Comande thermostatique vanne à la gauche.



Codice Code	Misura Size Dimensions	Tube pipe tube
120KB 015 R 12	1/2" x 3/4" - 9100BB incluso/included	Ø 12
120KB 015 R 14	1/2" x 3/4" - 9100BB incluso/included	Ø 14
120KB 015 R 15	1/2" x 3/4" - 9100BB incluso/included	Ø 15
120KB 015 M 16 12	1/2" x 3/4" - 9200BB incluso/included	16 x 2

320TB S

DETTENORE CON PORTA RESISTENZA ELETTRICA
PER FUNZIONAMENTO MISTO. FINITURA BIANCA.

*Lockshield with electrical resistance holder for mixed use.
White finishing.*

*Détendeur de radiateur avec support
de résistance électrique
pour un usage mixte.
Finition blanche.*

RAL 9016

SINISTRA
Left
Gauche



Codice Code	Misura Size Dimensions		
320TB 015 S	1/2" x 3/4" EK sinistra - left - gauche	15	60

120TB D

VALVOLA TERMOSTATIZZABILE CON PORTA RESISTENZA ELETTRICA
PER FUNZIONAMENTO MISTO. FINITURA BIANCA.

*Thermostatic valve with electrical resistance holder for mixed use.
White finishing.*

*Vanne thermostatique avec support
de résistance électrique
pour un usage mixte.
Finition blanche.*

RAL 9016

DESTRA
Right
Droite



Codice Code	Misura Size Dimensions		
120TB 015 D	1/2" x 3/4" EK destra - right - droite	15	60

125TB

VALVOLE TERMOSTATIZZABILI A SQUADRA CON
PORTA RESISTENZA ELETTRICA PER FUNZIONAMENTO
MISTO. FINITURA BIANCA. VALVOLA
TERMOSTATIZZABILE A DESTRA.

*Angle thermostatic valves
with electrical resistance
holder for mixed use.
White finishing.
Thermostatically controlled
valve to the right.*

*Vannes thermostatables
à coulisse avec porte résistance
électrique pour fonctionnement
mixte. Finition blanche.
Comande thermostatique
vanne à la droite.*

DESTRA >
Right
Droite



Codice Code	Misura Size Dimensions
125TB 015	1/2" x 3/4" EK Coppia - Pair - Couple

125KCR - 125KCM

KIT VALVOLE TERMOSTATIZZABILI A SQUADRA CON
PORTA RESISTENZA ELETTRICA PER FUNZIONAMENTO
MISTO. FINITURA BIANCA. VALVOLA
TERMOSTATIZZABILE A DESTRA.

*Kit angle thermostatic valves with electrical
resistance holder for mixed use. White finishing.
Thermostatically controlled valve to the right.*

*Set vannes thermostatables à coulisse
avec porte résistance électrique pour
fonctionnement mixte. Finition blanche.
Comande thermostatique vanne à la droite.*

9100BB**9200BB**

Codice Code	Misura Size Dimensions	Tubo pipe tube
125KB 015 R 12	1/2" x 3/4" - 9100BB incluso/included	Ø 12
125KB 015 R 14	1/2" x 3/4" - 9100BB incluso/included	Ø 14
125KB 015 R 15	1/2" x 3/4" - 9100BB incluso/included	Ø 15
125KB 015 M 16 12	1/2" x 3/4" - 9200BB incluso/included	16 x 2

2TT BB

TESTA TERMOSTATICA CON SENSORE
A LIQUIDO. FINITURA BIANCA.

*Thermostatic head with liquid sensor.
White finishing.*

*Tête thermostatique avec capteur de liquide.
Finition blanche.*



Codice Code	Misura Size Dimensions
2TT BB	M 30 x 1,5

VALVOLA TERMOSTATIZZABILE CON PORTA RESISTENZA ELETTRICA PER FUNZIONAMENTO MISTO FINITURA NERA

Thermostatic valve with electrical resistance holder for mixed use, black finishing

Vanne thermostatique avec support de résistance électrique pour un usage mixte, finition noire

120NN S

VALVOLA TERMOSTATIZZABILE CON PORTA RESISTENZA ELETTRICA PER FUNZIONAMENTO MISTO. FINITURA NERA.

Thermostatic valve with electrical resistance holder for mixed use. Black finishing.

Vanne thermostatique avec support de résistance électrique pour un usage mixte. Finition noire.

RAL 9004



SINISTRA
Left
Gauche

Codice Code	Misura Size Dimensions		
120NN 015 S	1/2" x 3/4" EK sinistra - left - gauche	15	60

320NN D

DETENTORE CON PORTA RESISTENZA ELETTRICA PER FUNZIONAMENTO MISTO. FINITURA NERA.

Lockshield with electrical resistance holder for mixed use. Black finishing.

Détendeur de radiateur avec support de résistance électrique pour un usage mixte. Finition noire.

RAL 9004



DESTRA
Right
Droite

Codice Code	Misura Size Dimensions		
320NN 015 D	1/2" x 3/4" EK destra - right - droite	15	60

120NN

VALVOLE TERMOSTATIZZABILI A SQUADRA CON PORTA RESISTENZA ELETTRICA PER FUNZIONAMENTO MISTO. FINITURA NERA. VALVOLA TERMOSTATIZZABILE A SINISTRA.

Angle thermostatic valves with electrical resistance holder for mixed use. Black finishing. Thermostatically controlled valve to the left.

Vannes thermostatables à coulisse avec porte résistance électrique pour fonctionnement mixte. Finition noire. Comande thermostatique vanne à la gauche.



SINISTRA >
Left
Gauche

Codice Code	Misura Size Dimensions
120NN 015	1/2" x 3/4" EK Coppia - Pair - Couple

120KNNR - 120KNNM

KIT VALVOLE TERMOSTATIZZABILI A SQUADRA CON PORTA RESISTENZA ELETTRICA PER FUNZIONAMENTO MISTO. FINITURA NERA. VALVOLA TERMOSTATIZZABILE A SINISTRA.

Kit angle thermostatic valves with electrical resistance holder for mixed use. Black finishing. Thermostatically controlled valve to the left.

Set vannes thermostatables à coulisse avec porte résistance électrique pour fonctionnement mixte. Finition noire. Comande thermostatique vanne à la gauche.



Codice Code	Misura Size Dimensions	Tube pipe tube
120KNN 015 R 12	1/2" x 3/4" - 9100NN incluso/included	Ø 12
120KNN 015 R 14	1/2" x 3/4" - 9100NN incluso/included	Ø 14
120KNN 015 R 15	1/2" x 3/4" - 9100NN incluso/included	Ø 15
120KNN 015 M 16 12	1/2" x 3/4" - 9200NN incluso/included	16 x 2

320NN S

DETTENORE CON PORTA RESISTENZA ELETTRICA PER FUNZIONAMENTO MISTO. FINITURA NERA.

Lockshield with electrical resistance holder for mixed use. Black finishing.

Détendeur de radiateur avec support de résistance électrique pour un usage mixte. Finition noire.

RAL 9004

SINISTRA
Left
Gauche



Codice Code	Misura Size Dimensions	15	60
320NN 015 S	1/2" x 3/4" EK sinistra - left - gauche	15	60

120NN D

VALVOLA TERMOSTATIZZABILE CON PORTA RESISTENZA ELETTRICA PER FUNZIONAMENTO MISTO. FINITURA NERA.

Thermostatic valve with electrical resistance holder for mixed use. Black finishing.

Vanne thermostatique avec support de résistance électrique pour un usage mixte. Finition noire.

RAL 9004

DESTRA
Right
Droite



Codice Code	Misura Size Dimensions	15	60
120NN 015 D	1/2" x 3/4" EK destra - right - droite	15	60

125NN

VALVOLE TERMOSTATIZZABILI A SQUADRA CON PORTA RESISTENZA ELETTRICA PER FUNZIONAMENTO MISTO. FINITURA NERA. VALVOLA TERMOSTATIZZABILE A DESTRA.

Angle thermostatic valves with electrical resistance holder for mixed use. Black finishing. Thermostatically controlled valve to the right.

Vannes thermostatables à coulisse avec porte résistance électrique pour fonctionnement mixte. Finition noire. Comande thermostatique vanne à la droite.

DESTRA >
Right
Droite



Codice Code	Misura Size Dimensions
125NN 015	1/2" x 3/4" EK Coppia - Pair - Couple

125KNNR - 125KNNM

KIT VALVOLE TERMOSTATIZZABILI A SQUADRA CON PORTA RESISTENZA ELETTRICA PER FUNZIONAMENTO MISTO. FINITURA NERA. VALVOLA TERMOSTATIZZABILE A DESTRA.

Kit angle thermostatic valves with electrical resistance holder for mixed use. Black finishing. Thermostatically controlled valve to the right.

Set vannes thermostatables à coulisse avec porte résistance électrique pour fonctionnement mixte. Finition noire. Comande thermostatique vanne à la droite.

9100NN

9200NN



Codice Code	Misura Size Dimensions	12	14	15	16 12	16 x 2
125KNN 015 R	1/2" x 3/4" - 9100NN incluso/included	Ø 12				
125KNN 015 R	1/2" x 3/4" - 9100NN incluso/included	Ø 14				
125KNN 015 R	1/2" x 3/4" - 9100NN incluso/included	Ø 15				
125KNN 015 M	1/2" x 3/4" - 9200NN incluso/included				16 x 2	

2TT NN

TESTA TERMOSTATICA CON SENSORE A LIQUIDO. FINITURA NERA.

Thermostatic head with liquid sensor. Black finishing.

Tête thermostatique avec capteur de liquide. Finition noire.



Codice Code	Misura Size Dimensions
2TT NN	M 30 x 1,5

9100TA

ADATTATORE A COMPRESSIONE CON TENUTA IN GOMMA PER TUBO RAME.

Adapter for copper pipe.

Raccord à compression avec joint en caoutchouc pour tube cuivre.



Codice Code	Misura Size Dimensions	Per tubo For pipe Pour tube
9100TA 12 020	Ø 12 x 3/4"	Ø 12
9100TA 14 020	Ø 14 x 3/4"	Ø 14
9100TA 15 020	Ø 15 x 3/4"	Ø 15

9100BB

ADATTATORE A COMPRESSIONE CON TENUTA IN GOMMA PER TUBO RAME. FINITURA BIANCA.

Adapter for copper pipe. White finishing.

Raccord à compression avec joint en caoutchouc pour tube cuivre. Finition blanche.



RAL 9016

Codice Code	Misura Size Dimensions	Per tubo For pipe Pour tube
9100BB 12 020	Ø 12 x 3/4"	Ø 12
9100BB 14 020	Ø 14 x 3/4"	Ø 14
9100BB 15 020	Ø 15 x 3/4"	Ø 15

9100NN

ADATTATORE A COMPRESSIONE CON TENUTA IN GOMMA PER TUBO RAME. FINITURA NERA.

Adapter for copper pipe. Black finishing.

Raccord à compression avec joint en caoutchouc pour tube cuivre. Finition noire.



RAL 9004

Codice Code	Misura Size Dimensions	Per tubo For pipe Pour tube
9100NN 12 020	Ø 12 x 3/4"	Ø 12
9100NN 14 020	Ø 14 x 3/4"	Ø 14
9100NN 15 020	Ø 15 x 3/4"	Ø 15

9200TA

ADATTATORE A COMPRESSIONE CON TENUTA O-RING E ANELLO PTFE PER TUBO PEX E MULTISTRATO.

Adapter for PEX/AL-PEX.

Raccord à compression avec O-Ring et anneau PTFE pour tubes PEX et multicouches.



Codice Code	Misura Size Dimensions	Per tubo For pipe Pour tube
9200TA 16 12 020	16/12 x 3/4"	16 x 2

9200BB

ADATTATORE A COMPRESSIONE CON TENUTA O-RING E ANELLO PTFE PER TUBO PEX E MULTISTRATO. FINITURA BIANCA.

Adapter for PEX/AL-PEX. White finishing.

Raccord à compression avec O-Ring et anneau PTFE pour tubes PEX et multicouches. Finition blanche.



RAL 9016

Codice Code	Misura Size Dimensions	Per tubo For pipe Pour tube
9200BB 16 12 020	16/12 x 3/4"	16 x 2

9200NN

ADATTATORE A COMPRESSIONE CON TENUTA O-RING E ANELLO PTFE PER TUBO PEX E MULTISTRATO. FINITURA NERA.

Adapter for PEX/AL-PEX. Black finishing.

Raccord à compression avec O-Ring et anneau PTFE pour tubes PEX et multicouches. Finition noire.



RAL 9004

Codice Code	Misura Size Dimensions	Per tubo For pipe Pour tube
9200NN 16 12 020	16/12 x 3/4"	16 x 2

COLLETTORI DI DISTRIBUZIONE E RACCORDERIA

Manifolds and fittings

Collecteurs de distribution et raccords

RACCORDERIA

Fittings Raccords

COLLETTORI LINEARI

Linear manifolds Collecteurs linéaires

ADATTATORI

Adapter Adaptateurs

RACCORDERIA

Fittings

Adaptateurs et raccords

9100

ADATTATORE A COMPRESSIONE CON TENUTA IN GOMMA PER TUBO RAME. COMPATIBILE CON I COLLETTORI 440MV.

Adapter for copper pipe. Compatible with 440MV manifolds.

Raccord à compression avec joint d'étanchéité en caoutchouc pour tube cuivre. Compatible avec les collecteurs 440MV.



Codice Code	Misura Size	Dimensions	📦	📦
9100 12 015	Ø 12 x 1/2"		80	320
9100 15 015	Ø 15 x 1/2"		80	320

9200

ADATTATORE A COMPRESSIONE CON TENUTA O-RING E ANELLO PTFE PER TUBO PEX E MULTISTRATO. COMPATIBILE CON I COLLETTORI 440MV.

Adapter for PEX/AL-PEX. Compatible with 440MV manifolds.

Raccord à compression avec O-ring et bague en PTFE pour tube PEX et multicouche. Compatible avec les collecteurs 440MV.



Codice Code	Misura Size	Dimensions	Per tubo Pour tube	📦	📦
9200 14 10 015	14/10 x 1/2"		14 x 2	80	320
9200 16 12 015	16/12 x 1/2"		16 x 2	80	320
9150 16 11,6 015	16/11,6 x 1/2"		PEX 16 x 2,2	80	320

9550

RACCORDO IN OTTONE DRITTO 3 PEZZI F/M. FINITURA NICHELATA.

Three pieces straight union F/M. Nickel finishing.

Raccord en laiton droit 3 pièces F/M. Finition nickelée.



Codice Code	Misura Size	Dimensions	📦	📦
9550 015	1/2"		70	280
9550 020	3/4"		40	160
9550 025	1"		20	80
9550 032	1 1/4"		15	60

9560

RACCORDO IN OTTONE CURVO 3 PEZZI F/M. FINITURA NICHELATA.

Three pieces elbow union F/M. Nickel finishing.

Raccord en laiton coudé 3 pièces F/M. Finition nickelée.



Codice Code	Misura Size	Dimensions	📦	📦
9560 015	1/2"		40	160
9560 020	3/4"		30	120
9560 025	1"		12	48
9560 032	1 1/4"		9	36

COLLETTORI LINEARI

Linear manifolds

Collecteurs linéaires

COLLETTORE DI DISTRIBUZIONE MODULARE IN OTTONE STAMPATO.

- FINITURA NICKEL
- VITONE MANUALE
- MANIGLIE DI REGOLAZIONE IN PLASTICA
- GUARNIZIONI DI TENUTA NBR
- FILETTATURE SECONDO UNI ISO 228/1
- LIMITI DI PRESSIONE 10 BAR (PN 10)
- LIMITI DI TEMPERATURA -10 +110 °C

Modular distribution manifold in forged brass.

- Nickel finish
- Manual screw
- Plastic adjustment handles
- NBR seals
- Threads according to UNI ISO 228/1
- Pressure limits 10 bar (PN 10)
- Temperature range -10 +110 °C

Collecteur de distribution modulaire en laiton pressé.

- Finition nickel
- Vis manuelle
- Poignées de réglage en plastique
- Joints NBR
- Filetages selon UNI ISO 228/1
- Limites de pression 10 bar (PN 10)
- Limites de température -10 +110 °C

440MV2

COLLETTORE CON VITONE, ATTACCO DA 1/2" M. FINITURA NICHELATA.

Manifold with headworks, 1/2" M outlet. Nickel finishing.

Collecteur avec tête, sortie 1/2" M. Finition nickelée.

PASSO 36 MM
Pitch 36mm
E.A. 36mm



Codice Code	Misura Size Dimensions		
440MV2 020	3/4" x 1/2"	16	64
440MV2 025	1" x 1/2"	4	40

440MV3

COLLETTORE CON VITONE, ATTACCO DA 1/2" M. FINITURA NICHELATA.

Manifold with headworks, 1/2" M outlet. Nickel finishing.

Collecteur avec tête, sortie 1/2" M. Finition nickelée.

PASSO 36 MM
Pitch 36mm
E.A. 36mm



Codice Code	Misura Size Dimensions		
440MV3 020	3/4" x 1/2"	10	40
440MV3 025	1" x 1/2"	6	36

440MV4

COLLETTORE CON VITONE, ATTACCO DA 1/2" M. FINITURA NICHELATA.

Manifold with headworks, 1/2" M outlet. Nickel finishing.

Collecteur avec tête, sortie 1/2" M. Finition nickelée.

PASSO 36 MM
Pitch 36mm
E.A. 36mm



Codice Code	Misura Size Dimensions		
440MV4 020	3/4" x 1/2"	8	32
440MV4 025	1" x 1/2"	4	24



7

VALVOLE DI SICUREZZA

Safety valves

Vannes de sûreté

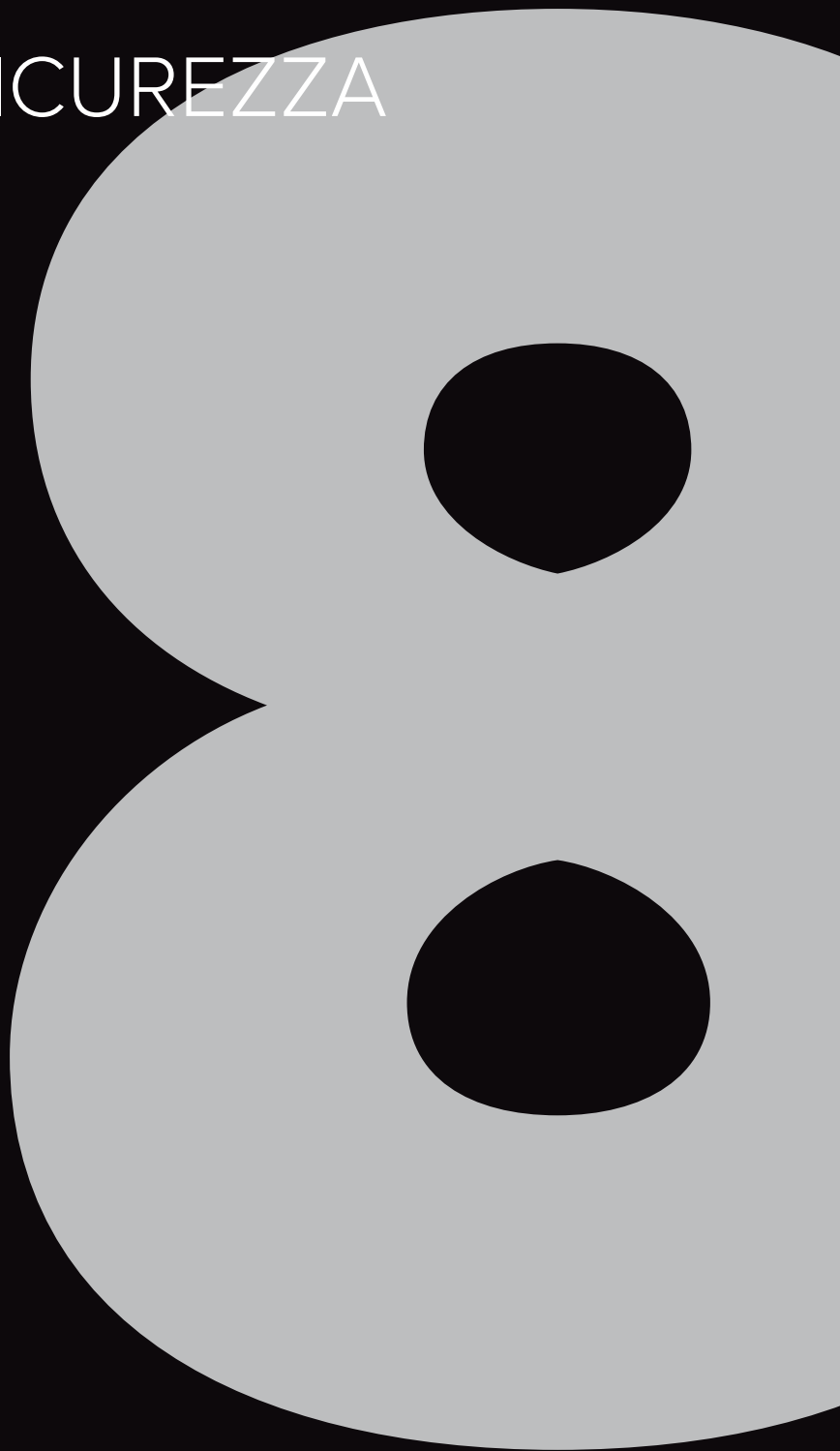

VALVOLE DI SFOGO ARIA

Air vents Purgeurs

VALVOLE DI SICUREZZA

Safety valves Vannes de sûreté

VALVOLE DI SFOGO ARIA

Air vents

Purgeurs d'air

5805K

KIT VALVOLA DIRITTA DI SFOGO ARIA AUTOMATICA, A GALLEGGIANTE, CON VALVOLA DI NON RITORNO.

Kit straight automatic air vent. With check valve for automatic air vent.

Set purgeur d'air droit avec flotteur. Avec clapet automatique.

PN 10 - 110°C



Codice Code	Misura Size	Dimensions		
5805K 010	3/8"		1	80
5805K 015	1/2"		1	80

5805

VALVOLA DIRITTA DI SFOGO ARIA AUTOMATICA, A GALLEGGIANTE.

Straight automatic air vent.

Purgeur d'air droit avec flotteur.

PN 10 - 110°C



Codice Code	Misura Size	Dimensions		
5805 010	3/8"		1	90
5805 015	1/2"		1	90

5802

VALVOLA DIRITTA DI SFOGO ARIA AUTOMATICA, A GALLEGGIANTE, CON SFIATO LATERALE.

Straight automatic air vent, with lateral drain-off.

Purgeur d'air droit avec flotteur, sortie latérale.

PN 10 - 110°C



Codice Code	Misura Size	Dimensions		
5802 010	3/8"		16	160
5802 015	1/2"		16	160

5803

VALVOLA DI SFOGO ARIA AUTOMATICA, A GALLEGGIANTE, CON ATTACCO LATERALE.

Automatic air vent, with lateral inlet.

Purgeur d'air avec flotteur, avec raccordement latéral.

PN 10 - 110°C



Codice Code	Misura Size	Dimensions		
5803 015	1/2"		1	72

5820

VALVOLA DI NON RITORNO PER VALVOLE DI SFOGO ARIA AUTOMATICA.

Check valve for automatic air vent.

Clapet automatique pour robinet purgeur d'air.

PN 10 - 110°C



Codice Code	Misura Size	Dimensions		
5820 010	3/8"		150	600
5820 015	1/2"		60	600

7025

VALVOLA DOPPIO RITEGNO M/F, ISO 228, IN OTTONE.

Double check valve M/F, made of brass.

Doubles clapet anti-retour M/F, ISO 228 en laiton.

PN 10 - 110°C



Codice Code	Misura Size	Dimensions		
7025 020	3/4"		25	100

5730

RUBINETTO DI SCARICO ORIENTABILE PER RADIATORE M1/2" CON ORING.

Adjustable drain valve for radiator M1/2" with oring.

Purgeur d'air orientable pour radiateur avec O.R.



Codice Code	Misura Size	Dimensions		
5730 015	1/2"		50	500

VALVOLE DI SICUREZZA

Safety valves

Vannes de sûreté

DISPOSITIVO DI AMMORTIZZAZIONE DEL COLPO D'ARIETE.

- CORPO IN OTTONE
- MOLLA IN ACCIAIO INOX AISI 302
- GUARNIZIONE IN GOMMA EPDM
- PISTONE IN POM
- FINITURA SUPERFICIALE SABBIATA CROMATA
- ATTACCO MASCHIO G1/2" ISO 228/1
- PN NOMINALE: 10 BAR
- PRESSIONE MAX DEL COLPO D'ARIETE: 50 BAR
- TEMPERATURA MAX: 90°C
- CLASSE PDI: C

Water hammer arrestor device.

- Brass body
- AISI 302 spring
- EPDM gasket rubber
- Disc in POM Material
- Chrome finishing
- Male connection G1/2" to ISO 228/1
- Nominal pressure: 10 bar
- Maximum pressure: 50 bar
- Maximum working temperature: 90°C
- PDI Class: C

Dispositif d'amortissement du coup de bélier.

- Corps en laiton
- Ressort en acier inoxydable AISI 302
- Joint en caoutchouc EPDM
- Piston en POM
- Finition de surface sablée chromée
- Fixation mâle G1/2" ISO 228/1
- PN nominal: 10 bar
- Pression maximale du bélier: 50 bar
- Température max: 90°C
- Classe PDI: C

5825

DISPOSITIVO DI AMMORTIZZAZIONE DEL COLPO D'ARIETE.

Water hammer arrestor device.

Dispositif d'amortissement du coup de bélier.



Codice Code	Misura Size Dimensions	1	60
5825 015	1/2"	1	60

VALVOLE DI SICUREZZA IN OTTONE STAMPATO.

- MOLLA IN ACCIAIO AISI304
- CAPPuccio IN PLASTICA
- MEMBRANA IN EPDM
- FILETTATURE SECONDO UNI ISO 228/1
- PRESSIONE DI TARATURA (VEDI TABELLA)
- LIMITI DI TEMPERATURA +5 +110 °C

Safety valves in forged brass.

- Spring in AISI304 steel
- Plastic cap
- EPDM membrane
- Threads according to UNI ISO 228/1
- Calibration pressure (see table)
- Temperature range +5 +110 °C

Soupapes de sécurité en laiton pressé.

- Ressort en acier AISI304
- Casquette en plastique
- Membrane EPDM
- Filetages selon UNI ISO 228/1
- Pression d'étalonnage (voir tableau)
- Limites de température +5 +110 °C

610

VALVOLA DI SICUREZZA F.

Safety valve F end.

Vanne de sûreté F.



Codice Code	Misura Size Dimensions	10	100
610 015 2,5	1/2" 2,5 bar	10	100
610 015 3	1/2" 3 bar	10	100
610 015 4	1/2" 4 bar	10	100
610 015 6	1/2" 6 bar	10	100
610 020 2,5	3/4" 2,5 bar	10	100
610 020 3	3/4" 3 bar	10	100
610 020 4	3/4" 4 bar	10	100
610 020 6	3/4" 6 bar	10	100

620

VALVOLA DI SICUREZZA M.

Safety valve M end.

Vanne de sûreté M.



Codice Code	Misura Size Dimensions	10	100
620 015 3	1/2" 3 bar	10	100
620 015 4	1/2" 4 bar	10	100
620 015 6	1/2" 6 bar	10	100



La APM srl è una società di recente costituzione che grazie al suo dinamismo e ad un'accorta ed organizzata gestione aziendale sta ottenendo un notevole sviluppo ed un consenso sempre più ampio a livello nazionale ed estero.

Supportata da uno staff di tecnici e progettisti interni è in grado di immettere sul mercato prodotti creati e realizzati accuratamente e sottoposti a severi test di controllo e qualità che ne costituiscono garanzie di funzionalità.

Azienda estremamente flessibile, propone un'ampia gamma di prodotti, in continuo sviluppo e di sicura affidabilità.

APM srl has been recently founded but, thanks to its dynamic spirit and its good global management, it is growing considerably in both national and international markets.

The Apm staff of designers and experts has the target to develop and create appropriate products for the market, to make them safe and reliable after deep controls and quality checks.

Apm flexibility supported by a first class management and staff allows a continue development in terms of reliability and variety of product range.

La Soc. APM est une réalité très dynamique qui a pris naissance en 1997 et grâce à son dynamisme et à son organisation de gestion, elle est entrain d'obtenir un remarquable développement et une réussite toujours plus importante au niveau national ainsi qu'à l'étranger.

Grâce à son équipe de techniciens et concepteurs, elle est en mesure d'offrir sur les différents marchés, des produits créés et réalisés avec soin et lesquels sont soumis à des tests sévères de contrôle et de qualité, ce qui nous permet d'offrir des garanties de fonctionnalité.

Société extrêmement flexible, orientée vers la satisfaction du client, propose une ample gamme de produits fiables et en continue évolution afin de répondre toujours mieux aux exigences de toute sa clientèle.

SITO WEB

Web site
Site web



www.apm.cc



DOVE SIAMO

Our location
Plan d'accès

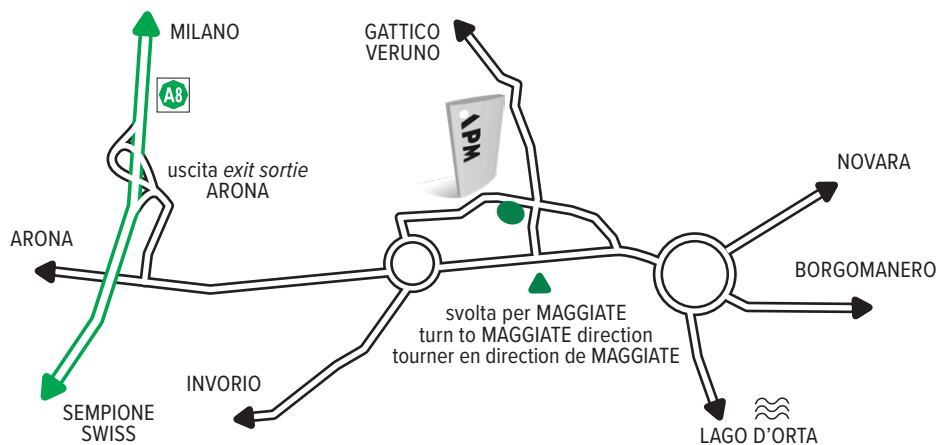

CONDIZIONI DI VENDITA

Terms of sale

Conditions de vente

CONDIZIONI DI VENDITA

- 1) Con il conferimento dell'ordine il cliente accetta pienamente tacitamente tutte le condizioni di vendita e di consegna sotto-stanti.
- 2) Gli ordini sono ricevuti da APM con riserva di accettazione da parte della casa. La data di consegna che l'Azienda indicherà sulla conferma d'ordine è da ritenersi del tutto indicativa e non tassativa: non si accoglierà pertanto la richiesta di eventuali danni che il destinatario abbia a reclamare per anticipata o ritardata consegna.
- 3) La data di consegna indicata sulla conferma d'ordine riguarda il giorno previsto in cui la merce sarà consegnata al corriere. APM non è quindi responsabile se eventuali ritardi saranno causati dal vettore.
- 4) Le spese di trasporto e assicurazione nonché i rischi connessi al trasporto sono a carico del destinatario e la consegna dei prodotti avviene presso i magazzini di APM. L'Azienda garantisce al destinatario delle merci la massima cura negli imballi e attenzioni nel carico degli stessi. La responsabilità dell'Azienda cessa quindi in ogni caso con la consegna della merce al vettore.
- 5) Tutti gli articoli sono accuratamente provati e controllati. La responsabilità di APM sulla qualità del materiale si limita ad accettare il reso, in porto franco, di pezzi riscontrati difettosi e comunque non manomessi per disporre la sostituzione.
- 6) Eventuali reclami dovranno, sotto pena di decadenza, essere avanzati entro 8 giorni dall'effettivo arrivo a destinazione della merce e sempre a materiale non posto in opera, mentre gli eventuali reclami riguardanti i difetti degli imballi e l'eventuale mancanza di colli devono essere indicati sui documenti di trasporto al momento della consegna e immediatamente segnalati alla nostra sede via fax.
- 7) Le merci oggetto di contestazione previa autorizzazione scritta da parte di un responsabile APM, devono essere restituite in porto franco entro 30 giorni dalla data della contestazione ad APM che provvederà alla loro sostituzione. Nel caso che la restituzione non avvenga, esse saranno considerate acquisite e quindi normalmente fatturate.
- 8) Non è consentito al destinatario di respingere o rendere la merce ricevuta senza previa ed espressa autorizzazione del mittente.
- 9) I pagamenti devono essere effettuati presso il domicilio di APM a Maggiate frazione di Gattico (No), nella valuta convenuta, con le modalità e nei termini indicati nella conferma d'ordine o nella fattura. Pagamenti fatti in luoghi diversi, anche se accettati, avranno unicamente valore di mera tolleranza.
- 10) In caso di ritardato o mancato pagamento, saranno addebitati gli interessi di mora come ed ai sensi dell'art.5 D.Lgs 231/2002. In caso di insoluto, saranno addebitate tutte le spese bancarie derivanti. In caso di pagamenti a mezzo bonifico bancario, le spese bancarie sono a carico dell'ordinante.
- 11) L'Azienda ha la facoltà di sospendere le forniture senza preavviso alcuno se le condizioni economiche del destinatario arrecassero pericolo al conseguimento del pagamento delle stesse. Il mancato pagamento nei termini stabiliti dà diritto ad APM a sospendere le consegne successive senza preavviso e di ritenere risolto il contratto per colpa dell'acquirente.
- 12) Eventuali contestazioni o reclami non autorizzano il committente a sospendere i pagamenti.
- 13) Le merci sono vendute con il patto di riservato dominio ai sensi art. 1523 e segg. Codice Civile; di conseguenza, fino a totale pagamento dell'intero prezzo, di eventuali interessi e di spese accessorie, esse rimarranno di proprietà del mittente.
- 14) Le illustrazioni dei nostri cataloghi e deplianti hanno lo scopo di dimostrare e rappresentare i singoli articoli e non costituiscono quindi obbligo di fedele esecuzione. I dettagli, le misure ed i pesi indicati sono da considerarsi indicativi. Pertanto APM non si assume alcuna responsabilità in ordine a quanto sopra e conseguentemente non riconosce richieste per danni di qualsiasi specie.
- 15) APM ha facoltà di effettuare qualsiasi cambiamento tecnico stilistico dei propri prodotti senza preavviso alcuno.
- 16) I prezzi e tutte le informazioni contenute in questo catalogo non sono vincolanti per APM e possono essere oggetto di variazioni nel corso dell'anno.
- 17) Nessuna modifica o deroga alle presenti condizioni di vendita avrà efficacia tra le parti, se non risulterà espressamente da accordo scritto.
- 18) Per qualsiasi contestazione è sempre e solo competente il foro di Novara (Italia), anche se gli ordini siano rimessi altrove. Non hanno alcun valore e non vengono da APM riconosciute dichiarazioni impegnative o garanzie di sorta assunte dai propri dipendenti, agenti o rappresentanti che non risultino dalle presenti condizioni generali di vendita o da atti ufficialmente sottoscritti dalla Società.

TERMS OF SALE

- 1) On placement of the order the client fully and tacitly accepts all purchase and delivery terms specified below.
- 2) APM reserves the right to accept the orders received. The delivery date indicated on the order confirmation is intended as indicative and not binding: therefore any claim for compensation lodged by the client for damages resulting from anticipated or delayed delivery will not be accepted.
- 3) The delivery date indicated on the order confirmation refers to the date of delivery of the goods to the carrier. APM will not be responsible for any delay caused by the carrier.
- 4) All transportation and insurance charges as well as risks connected thereto will be charged to the client and goods delivered ex APM's warehouse. APM guarantees maximum care as to packaging and loading of the goods and therefore its responsibility will in any case cease on delivery of the goods to the carrier.
- 5) All products are carefully tested and controlled. APM's responsibility as to the quality of the materials is limited to the acceptance of defective work, and in any case not tampered, pieces for replacement.
- 6) Subject to forfeiture thereof any claim for compensation must be lodged by the client within 8 days from the actual receipt of the unused goods, while claims referred to packaging and/or missing parcels must be reported on the shipping documents at the time of delivery and immediately notified to our office by fax.
- 7) All products object of claim prior written consent of a responsible APM, must be returned ex works within 30 days from the date of claim to APM, who will arrange their replacement. If the goods are not returned they shall be automatically considered as purchased and shall be regularly invoiced to the client.
- 8) Goods rejections or returns by the client shall not be accepted without prior authorisation by APM.
- 9) All payments shall be addressed to APM's domicile in Maggiate of Gattico (No), in the currency agreed upon and according to the terms and conditions indicated on the order confirmation. Any payment addressed to a different location, even if accepted, shall be deemed as approved in the spirit of mere tolerance.
- 10) As set forth by art. 5 Italian Law 231/2002 interests on arrears shall be charged in case of delayed or failed payment. In case of outstanding debt all bank expenses shall be charged to the client and all costs deriving from bank transfers shall be charged to the ordering party.
- 11) APM reserves the right to stop the supplies without prior notification should the client's financial situation lead to a possible non-settlement of the related amounts. Failure to make a payment within the terms set forth by the contract shall entitle APM to recede from the agreement, stop all subsequent deliveries without prior notification and cancel the contract due to the client's fault.
- 12) Claims or disputes shall not authorize the client to stop the payments.
- 13) As set forth by art. 1523 and subsequent amendments of the Italian Civil Code the goods are sold under retention of title up to final settlement of the entire price plus any interest and accessory charges due, and shall remain property of the seller.
- 14) The only purpose of the pictures of our catalogues brochures is to show and represent the single item and do not constitute an obligation of faithful execution. The details, dimensions and weights given therein must be considered as indicative. APM does not acknowledge liability thereto and shall not accept claims for damages of any kind.
- 15) APM reserves the right to carry out technical and stylistic changes on its products without prior notification.
- 16) Prices and information contained in this catalogue are not binding for APM and can be changed at any time during the year.
- 17) No amendment or derogation to these sales terms shall be deemed valid between the parties unless expressly notified in writing.
- 18) Any and all controversies shall always be under the jurisdiction of the Court of Novara (Italy) even if orders are placed from other territories. APM shall not acknowledge committing statements or warranties of any kind expressed by its employees, agents or representatives other than the ones reported in these general sales terms or in other acts officially signed by APM itself.

CONDITIONS DE VENTE

- 1) a transmission d'une commande implique l'adhésion totale et intégrale, sans réserve, de la part du client des présentes conditions de vente et de livraison.
- 2) Les commandes sont reçues par APM sous réserve d'acceptation par cette dernière. La date de livraison que l'Entreprise indiquera sur la confirmation de la commande est indicative et non catégorique: par conséquent, la demande d'un éventuel dédommagement que le destinataire pourrait réclamer suite à une livraison anticipée ou retardée ne sera pas acceptable.
- 3) La date de livraison indiquée sur la confirmation de la commande concerne le jour prévu du départ usine de la marchandise. APM n'est pas responsable d'éventuels retards occasionnés par le transporteur.
- 4) Les frais d'expédition et d'assurance, sauf accords préalables, ainsi que les risques liés au transport sont à la charge du destinataire. L'Entreprise garantit au destinataire que les marchandises sont emballées et transportées avec le plus grand soin. Dans tous les cas, la responsabilité de l'Entreprise n'est plus engagée à la remise des marchandises au transporteur.
- 5) Tous les articles sont soigneusement testés et contrôlés. La responsabilité d'APM sur la qualité du matériel se limite à l'acceptation de la restitution, franco de port, des pièces défectueuses et bien sûr non altérées pour leur remplacement.
- 6) Les éventuelles réclamations, pour être prises effectivement en compte, devront nous parvenir dans un délai de 8 jours à compter de la date effective d'arrivée à destination de la marchandise qui n'aura pas été utilisée; par contre, pour éventuelles réclamations relatives aux défauts d'emballage et à une livraison incomplète, celles-ci devront être impérativement indiquées sur le bordereau de transport au moment de la réception du matériel et immédiatement signalées à notre siège par fax.
- 7) Les marchandises faisant objet d'une contestation doivent être signalées à la Société et seulement suite à une autorisation écrite de la part des responsables APM, elles pourront être restituées franco de port, dans les 30 jours suivants de la date de la contestation à APM, qui s'engagera à les remplacer. Dans le cas où les marchandises ne seraient pas restituées, elles seront considérées comme acquises et donc normalement facturées.
- 8) Le destinataire ne pourra en aucun cas refuser ou retourner la marchandise reçue sans l'autorisation préalable de l'expéditeur.
- 9) Les règlements devront être effectués au domicile d'APM à Maggiate Gattico (Novara-Italie), dans la devise convenue, selon les modalités et les termes indiqués dans la confirmation de la commande ou dans la facture. Les règlements réalisés dans des lieux différents seront acceptés à titre de simple tolérance.
- 10) En cas de retard ou d'absence de règlement, des intérêts moratoires seront appliqués conformément à l'art. 5 du Décret législatif italien 231/2002. En cas d'impayé, l'ensemble des frais bancaires relatifs à celui-ci seront facturés au client. En cas de règlement par virement bancaire et LCR, les frais sont à la charge du client.
- 11) L'Entreprise se réserve le droit de suspendre les fournitures sans aucun préavis, si les conditions économiques du destinataire sont jugées préjudiciables pour l'obtention du règlement des dites fournitures. L'absence de règlement dans les termes établis autorise APM à suspendre les livraisons successives sans préavis et à résilier le contrat pour le non respect des engagements de la part de l'acquéreur.
- 12) Les éventuelles contestations ou réclamations n'autorisent pas l'acquéreur à suspendre les règlements.
- 13) Les marchandises sont vendues avec la clause de réserve de propriété conformément à l'art. 1523 et suivant le Code civil italien; par conséquent, jusqu'au règlement effectif de leur prix total, d'éventuels intérêts et des frais accessoires, les marchandises demeureront de la propriété de l'expéditeur.
- 14) Les illustrations de nos catalogues et de nos dépliant ont pour but la simple démonstration et représentation de nos articles et n'ont aucunes valeurs contractuelles. Les détails, les dimensions et les poids mentionnés sont indicatifs. Par conséquent, APM ne pourra être tenue comme responsable de ce qui précède et ne prendra donc en considération aucune demande de dédommagement à ce titre.
- 15) APM se réserve le droit d'effectuer tout changement technique et stylistique de ses produits sans aucun préavis.
- 16) Les prix et les informations contenues dans ce catalogue n'engagent en aucune manière APM et peuvent être sujets à des variations au cours de l'année.
- 17) Toutes modifications ou dérogations aux présentes conditions de vente n'auront de valeur contractuelle que si les parties les stipulent expressément par écrit.
- 18) Pour tout litige, seul le Tribunal de Novara (Italie) sera compétent, même si les commandes ont été livrées ailleurs. Toute déclaration d'engagement ou toute garantie, prise par ses propres salariés, agents ou représentants, ne figurant pas dans les présentes conditions de ventes ou dans des actes officiellement souscrits par la Société n'a aucune valeur et ne sera pas reconnue par APM.

APM

s.r.l.

Via Mirabella, 1 • fraz. Maggiate
28013 Gattico-Veruno (No) - Italy

Tel. +39.0322.880707 • Fax +39.0322.880704

info@apm.cc • www.apm.cc



RIVENDITORE AUTORIZZATO:
Authorized dealer:
Revendeur agréé:

ISO 9001
BUREAU VERITAS
Certification

